

# ***PROFIBUS***

## **Commissioning Guideline**

**Version 1.0.9**

**May 2015**

**Order No: 8.032**

**This document has been created by the “Installation Guide” (CB/PG3) working group of the PROFIBUS User Organization.**

**Publisher:**

**PROFIBUS Nutzerorganisation e.V.**

**Haid-und-Neu-Str. 7**

**76131 Karlsruhe**

**Germany**

**Phone: +49 721 / 96 58 590**

**Fax: +49 721 / 96 58 589**

**pi@profibus.com**

**www.profibus.com**

All rights reserved, including reprint, reproduction (photo copy, microfilm), storing in data processing systems, and translation, in whole or in part.

---

## **Revision log:**

Version	Date	Changes/History
0.2.2	24.06.04	3. Draft distribution for review
0.2.3	20.07.04	Changes according to the review of v.0.2.2 in Karlsruhe 01.07.04
0.2.4	09.08.04	Division into three documents (planning, assembly, commissioning)
0.2.5	26.11.04	4. Draft distribution for review Optical fibers chapter added Diagnostic telegram chapter added
0.2.6	05.02.05	Change according to review contributions
0.2.7	07.06.05	Change according to review contributions
0.2.8	17.09.05	Modified by A. Verwer
0.2.9	21.10.05	Workgroup review
0.2.10	30.10.05	Changes according to review comments
1.0.0	18.11.05	Official version created
1.0.1	07.02.06	Renaming of the document from Installation recommendation to Installation Guideline
1.0.2	03.08.11	Changes according to the phone conference on July 13 <sup>th</sup> 2011
1.0.3		Internal version
1.0.4		Review version for working group
1.0.5		Internal version, not published
1.0.6		Review version
1.0.7	21.11.14	Reviewed by head of working group
1.0.8	26.02.15	Translation of changed sections
1.0.9	13.05.15	Release Version

---

## Contents

Revision log: .....	3
Contents .....	4
List of Figures .....	6
List of Tables .....	7
Preface .....	8
Safety Information.....	9
Disclaimer of Liability .....	10
Reference Standards .....	11
Explanation of symbols .....	12
1 Simple PROFIBUS Diagnostics.....	15
1.1 Introduction.....	16
1.2 Handheld Devices .....	17
1.3 Optical fiber measurements.....	18
1.3.1 Attenuation measurement for optical fibers .....	18
1.3.2 OTDR measurement .....	20
1.3.3 Using optical fiber measurement processes.....	20
1.4 Communication statistics.....	21
2 Assembly Acceptance .....	23
2.1 Visual Inspection - PROFIBUS Copper and optical fiber Cable.....	25
2.2 Acceptance Measurements PROFIBUS RS-485.....	28
Description of the acceptance process steps.....	30
2.3 Acceptance Measurements - PROFIBUS MBP (PA).....	31
2.4 Acceptance measurements optical fiber.....	32
2.4.1 General.....	32
2.4.2 Measurement Results Damping Measurement.....	32
3 Commissioning / Acceptance .....	35
3.1 Bus test .....	36
3.2 Commissioning the bus .....	37
3.2.1 System configuration (step 3).....	37
3.2.2 Verifying PROFIBUS station addresses (step 4).....	40
3.2.3 Commissioning PROFIBUS stations (step 5) .....	41

---

3.2.4	Testing the Signal Inputs (step 6)	42
3.2.5	Testing the Signal Outputs (step 7)	42
3.2.6	Create acceptance checklist (step 8)	43
4	Troubleshooting	45
4.1	Introduction to troubleshooting	46
4.2	Checking the Cabling Infrastructure	47
4.3	Measurements with a Bus Monitor	48
4.4	The diagnostic telegram	49
4.5	Oscilloscope Measurements	51
4.5.1	Technical Prerequisites	51
4.5.2	Measurement Aids	52
4.5.3	Measurement PROFIBUS RS485	53
4.5.4	Typical Signal Waveforms	59
4.5.5	Measurements PROFIBUS MBP (PA)	64
4.6	Optical fiber measurements	68
5	Annex	69
5.1	Commissioning/Acceptance Checklists	70
5.2	Multimeter (instrument for measuring voltage, resistance, and current)	76
5.2.1	PROFIBUS RS485 with 9-Pin Sub-D Plug Connector	77
5.2.2	PROFIBUS RS485 with 5-Pin M 12 Plug Connectors	84
5.2.3	PROFIBUS MBP (PA) with 4-pin M 12 Plug connectors	85
6	Terms / Definitions / Abbreviations	91
7	Index	101
	Addresses	104

---

## List of Figures

Fig. 1: Attenuation measurement principle.....	18
Fig. 2: OTDR measurement principle .....	20
Fig. 3: Measurement plug oscilloscope measurement.....	53
Fig. 4: Potential shift at signals .....	57
Fig. 5: Ideal signal form PROFIBUS RS485 .....	58
Fig. 6: Measurement PROFIBUS RS-485.....	59
Fig. 7: Signal waveform for PROFIBUS cables that are too long.....	60
Fig. 8: Signal waveform for non-connected PROFIBUS stations .....	61
Fig. 9: Too much terminator resistance .....	62
Fig. 10: Missing terminator.....	63
Fig. 11: Ideal signal form PROFIBUS MBP (PA) .....	65
Fig. 12: PROFIBUS MBP (PA) with defective bus terminator .....	66
Fig. 13: Measurement PROFIBUS MBP (PA) (1 telegram).....	67
Fig. 14: OTDR measurement principle .....	68
Fig. 15: PROFIBUS RS485 cable schematic with end terminations switched in .....	79
Fig. 16: Measurement aid sockets (PROFIBUS RS485) .....	84

---

## **List of Tables**

Table 1: Maximum fiber attenuation - optical fiber .....	19
Table 2: Checklist for visual inspection of PROFIBUS copper cable .....	26
Table 3: Checklist for Acceptance measurements for PROFIBUS RS485 cabling .....	29
Table 4: Maximum fiber attenuation - optical fiber .....	33
Table 5: Resistance measurements for step 2 (PROFIBUS RS485) .....	81
Table 6: Resistance measurements for step 3 (PROFIBUS RS485) .....	82
Table 7: Resistance measurements for step 4 (PROFIBUS RS485) .....	82
Table 8: Loop Resistance PROFIBUS MBP (PA) cable .....	85
Table 9: Resistance measurements for step 2 (PROFIBUS MBP (PA)) .....	87
Table 10: Resistance measurements for step 3 (PROFIBUS MBP (PA)) .....	88
Table 11: Resistance measurements for step 4 (PROFIBUS MBP (PA)) .....	89

---

## ***Preface***

There are already a large number of documents available for PROFIBUS. So why is the Installation Guideline for Commissioning being added now? The answer is very simple. The existing documents have been created at different times and, therefore, feature a different structure. In addition, they contain extensive specifications directed at PROFIBUS component developers. The user does not require this information, and it can be more a source of confusion than an aid.

The Installation Guideline for Commissioning, as the name implies, is designed to support the commissioning of PROFIBUS systems. It helps you to verify proper installation and assembly of your PROFIBUS network. Moreover, the Installation Guideline helps you to locate possible errors. Consequently, the Installation Guideline for Commissioning is designed not only for commissioning personnel, but also for service personnel.

The presentation of information has been kept as simple as possible to ensure understandability. However, commissioning and troubleshooting do require previous PROFIBUS experience. Thus you should be familiar with the fundamentals involved in planning and assembling PROFIBUS systems. In addition you should have experience in implementing PROFIBUS systems.

The operating principle of PROFIBUS is not discussed in the Installation Guideline for Commissioning. If you require this information, please use the respective documents provided by the PI or corresponding technical literature.

Information on PROFIBUS assembly is available in the Installation Guideline (Order no. 8.022).

This document does not replace any existing document. The previous documents of the PI remain in effect.



---

## ***Safety Information***



The use of the PROFIBUS Installation Guideline for Commissioning may involve handling hazardous materials or tools, or involve dangerous work. Due to the many and diverse applications of PROFIBUS, it is not possible to take all options or safety requirements into consideration. Each system makes different demands. In order for you to competently judge possible dangers, you must inform yourself about the safety requirements of the respective system before starting your work. Special attention must be paid to adhering to the laws and regulations of the respective country in which the system will be operated. You should also observe general health and safety requirements, as well as the requirements of the company for whom the system is being built.

Also consider the documentation for the PROFIBUS components supplied by the manufacturer.

---

## ***Disclaimer of Liability***

This document is intended for information purposes only and is made available on the basis of a disclaimer of warranty. The document may be subject to changes, expansions or corrections in the future without specific notice. The PROFIBUS User Organization expressly rejects any form of contractual or legal liability for this document, including the warranty for defects and the warranty of usage qualities. In no case will the PROFIBUS User Organization be responsible for any losses or damages that occur or result from any type of defect, fault or omission in this document or from the use or reliance on this document by anyone.

---

## ***Reference Standards***

IEC 61158

Industrial communication networks – Fieldbus specifications

IEC 61508-4 (2011-02)

Functional safety of electrical / electronic / programmable electronic safety-related systems: Part 4: Definitions and abbreviations

IEC 61784-1 (2013-01)

Digital data communications for measurement and control – Part 1 Profile sets for continuous and discrete manufacturing relative to fieldbus use in industrial control systems.

---

## ***Explanation of symbols***

This document contains many graphics. They are intended to facilitate an understanding of the text. The graphics are generally displayed in black and white. The color violet is used only for emphasizing important details. The following field shows the color used.



The following line shape is used to display equipotential bonding and grounding cable.



In addition, the following symbol is used to display the grounding connection.



Furthermore, the following symbols are used. They denote particularly important text passages.



**Danger!**

The symbol indicates a danger for life and health. Following the instruction is extremely important!



**Caution!**

The symbol indicates a danger for property damage. Observing the instruction is intended to avoid property damages.

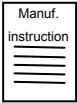

## Manufacturer instruction

The symbol on the left indicates that you must follow the manufacturer's instructions. In this case, the information in this Guide represents supplemental information.



## Note

The symbol indicates interference hazard. Following the instruction reduces the risk of interference.



## Tip

Tips provide practical instructions that facilitate your work and improve the system structure.



---

# **1 Simple PROFIBUS Diagnostics**

## 1.1 Introduction

This chapter describes some simple diagnostic tools with which you can test the PROFIBUS cable installation. These tests are particularly important for cabling acceptance. The tools also help you locate errors that occur during installation. The following tools are introduced here.

- **Handheld devices**

Handheld devices are devices that have been especially developed for testing PROFIBUS cabling with RS485 interfaces. In addition to testing the installation, they offer additional functions, e. g. determining the reachable PROFIBUS stations. In order to use a handheld device it must be possible to connect the device to the PROFIBUS cable via a 9-pin Sub-D plug connector.

- **Attenuation measurement**

Measuring attenuation is the most simple test process for optical fibers. You can use it to determine the magnitude of brightness losses from one end of the optical fiber to the other.

- **Diagnostics buffer/Master statistics**

The diagnostic buffer and the master statistics provide the first clues for troubleshooting. They are integrated in the PROFIBUS stations and do not require any additional devices, except the programming device and corresponding software.



### 1.2 Handheld Devices

Handheld devices have been developed in order to simplify and speed up test procedures PROFIBUS installations. Measurements with a handheld device offer you faster checking than with a multimeter, clearer results and more diagnostic possibilities. In addition to examining the PROFIBUS cable, it is also possible to perform other measurements and checking of PROFIBUS stations.

The devices that are available on the market are similar in their functions and scope. However, they do differ in operation. This is why these devices are not described here in more detail.



If you want more precise information, ask the manufacturer. You must read the manufacturer's operating instructions.

When using hand-held devices to test cables and connectors, the test is usually performed from both ends of a segment. This kind of measurement ensures that typical cable faults such as short circuits, wire breaks, different impedances and cross-connections are detected. If there should be a cross-connection of wires in two connectors, this fault can be found by testing every connector on each segment. A common example of this type of fault is when an intermediate plug is wired with the cores swapped on both the incoming and outgoing PROFIBUS cable.

If no hand-held device should be available to you for testing, some basic measurements can also be performed by using a standard multimeter. Please refer to the Annex for a description of how to proceed.

## 1.3 Optical fiber measurements

### 1.3.1 Attenuation measurement for optical fibers

Attenuation or insertion-loss measurement (to IEC 60793-1-40B) is useful for optical fibers. The measurement can highlight losses in the optical fiber and/or connections. Light is emitted into one end of the fiber by the transmitter. A calibrated receiver measures the received light and thus indicates the losses. Attenuation or insertion-loss is normally specified in dB. In some countries, the term damping is also used to describe the same measurement

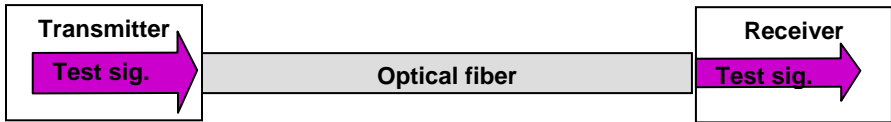

**Fig. 1: Attenuation measurement principle**

The following table provides information on the maximum attenuation for various PROFIBUS fiber types.

**Table 1: Maximum fiber attenuation - optical fiber**

	Singlemode fiber optic	Multimode fiber optic	PCF-/HCS <sup>1</sup> - fiber	Synthetic fiber	
				Standard	In-creased
Typical wavelength	1320 nm	850 nm	660 nm	660 nm	660 nm
Max. fiber attenuation	5 dB	6 dB	4 dB	6 dB	11.5 dB
*1 PCF and HCS are trademarks					

The measurement is performed in two steps. First the receiver must be calibrated. For this the measurement transmitter's transmission power is measured using a reference fiber. The reference fiber must be in very good condition and in particular, the connections must be polished to a very high quality. The reference fiber should only be used for a maximum of 500 reference measurements. Then the connections must be re-polished. After 2000 reference measurements the reference fiber must be replaced. Once the receiver has been calibrated, the measurement can be performed in a second step. The wavelength of the transmitted light must be tuned to the fiber type. Consequently, you will require a measurement system that matched the fiber being used.

- Only special reference fibers should be used to calibrate the receiver.
- The measurement must be performed with the transmitter that belongs to the test receiver. These subassemblies are matched. The PROFIBUS signal must be disabled during testing; otherwise the measurement will be corrupted.

Because the reference fiber connections are polished to a very high quality, they must be handled with the utmost care.

### 1.3.2 OTDR measurement

In addition to attenuation measurement, Optical Time Domain Reflectometers (OTDR) are also available. An OTDR can locate defective points in the optical fiber. To do this, the device transmits a signal into the optical fiber. Portions of the signal are reflected at connection points or interference points. The device measures the strength of the reflected part of the signal, and the delay after which the reflection is received. The measurement provides an indication on severity and location of a fault.

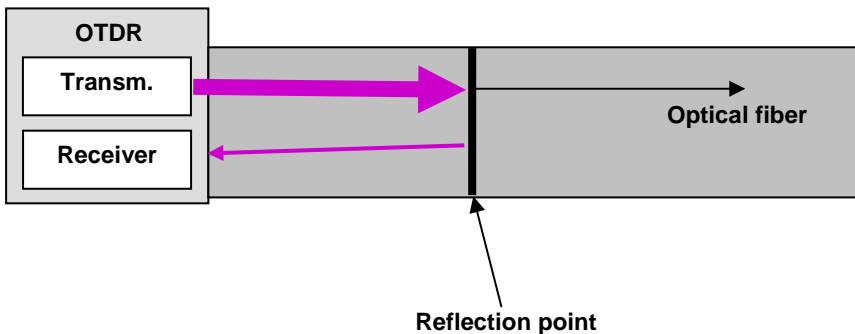

**Fig. 2: OTDR measurement principle**

This process is particularly demanding, as the results are not displayed in plain text. Normally there is a graphic display. The operator evaluates the measurement results and evaluation requires considerable experience.

### 1.3.3 Using optical fiber measurement processes

If you only process optical fibers on rare occasions, you should not purchase the measurement devices, due to the high costs and the required skill. Instead have a specialist firm perform this task.



However, if you do purchase an appropriate measurement system, then take a training course offered by the device manufacturer.

Please read the appropriate industry literature for more information.

## 1.4 Communication statistics

PROFIBUS telegrams may be corrupted by one of the following:

- Signal reflections resulting from cable faults (e.g. cable break, bad contacts, faulty terminating resistors, stubs)
- Especially high electromagnetic interference in the environment of the devices or cables
- Faulty devices

PROFIBUS has many mechanisms to ensure reliable communications even in the presence of such corruption. For example, any corrupted requests or missing or corrupted responses will cause the controlling master to repeat the request. The number of permissible retries can be configured by setting the “Retry-Limit”. Note that increasing the number of permissible retries will also increase the cycle time.

PROFIBUS systems can operate for long periods without visible error, even though a number of telegrams are being corrupted. Ideally, the commissioning engineer would like to know the extent of telegram corruption occurring on a network so that corrective measures can be taken.

Some PROFIBUS master stations have integrated counters that provide statistics on the quality or reliability of communications. These master components provide information on how many telegrams have been transmitted and how many had to be repeated. The counters count the number of valid and invalid telegrams received.

Examination of these counters provides a valuable indication of the condition of your PROFIBUS system. Any repeated or defective telegrams indicate problems within the PROFIBUS system. This information may be useful for commissioning.

It is often possible to gain access to the counters by using the corresponding planning software in the programming tool. For details please refer to the manufacturer’s documentation.

If your PROFIBUS master station should not have these counters, it is also possible to use external devices for determining telegram corruptions.



Please check the description provided by the manufacturer to learn which of the above-listed functions are available on your PROFIBUS master station.



---

## **2      Assembly Acceptance**

## **Assembly Acceptance**

---

The assembly acceptance procedure takes place after completing the installation. The installer can document that the assembly has been executed according to the planning and the regulations, through the assembly acceptance procedure.

Consequently, record the assembly acceptance results. The log can then be submitted to commissioning personnel.

At this point we discuss what should be done for the assembly acceptance procedure, and how to document the results. Each PROFIBUS segment should be individually tested and documented. Templates for the assembly acceptance documentation are provided in the Appendix.



### 2.1 Visual Inspection - PROFIBUS Copper and optical fiber Cable

Visual inspection of the PROFIBUS cabling should always be carried out before other tests are started. Visual inspection enables you to verify the installation had been carried out according to cabling guidelines. Errors like damaged PROFIBUS cable, insufficient bend radius, non-compliance with minimum spacing and other possible errors can be detected during this stage.

Table 2 provides a checklist of items that should be checked during visual inspection. The table applies to:

- PROFIBUS RS-485,
- PROFIBUS MBP (PROFIBUS PA) and
- PROFIBUS optical fiber cables

However, step 9 is not required for PROFIBUS MBP (PA) segments. Similarly, steps 2, 5, 9, and 13 can be skipped for optical fiber segments.

The Appendix provides checklists for visual inspection of PROFIBUS RS-485, PROFIBUS MBP (PA) and PROFIBUS optical fiber segments.

## Assembly Acceptance

---

**Table 2: Checklist for visual inspection of PROFIBUS copper cable**

1.	Cable laid according to plan?
2.	Cable type according to plan?
3.	Max. length of branch lines not exceeded?
4.	Connectors available according to plan (M12, Sub-D9, etc)?
5.	Minimum spacing between cabling has been complied with, or metal partitions have been inserted?
6.	PROFIBUS cable in order (no damage)?
7.	Bend radii specification observed?
8.	Cable crossings executed at right angles?
9.	Every segment provided with two powered terminating resistors?
10.	Guaranteed power supply for terminating resistors (even in case of emergency stop)?
11.	Sharp edges have been covered or removed?
12.	Safeguards against mechanical damage present at hazard points?
13.	At least one plug is present with programming device connection?
14.	Strain relief fixtures attached?
15.	Equipotential bonding established according to the regulations?
16.	Shielding is applied to the PROFIBUS stations, and connected to the equipotential bonding?
17.	Shielding on the cabinet entrance is connected with the equipotential bonding?
18.	Cable trays grounded?
19.	Subassemblies used in accordance with the structure plan (24 V/230 V subassemblies not reversed)?
20.	Transmission speed and PROFIBUS address are set according to structure plan?
21.	Channels not required are switched according to manufacturer's description?
22.	Proper measurement range selected on the analog subassembly (current/voltage)?

## Assembly Acceptance

Additionally in case of RS485-IS segments (Ex environment)	
23.	Fieldbus-isolating repeaters used only?
24.	Transmission rate limited to 1.5Mbit/s?
25.	No connectors with discrete inductors (e.g. 110 nH such as required for high transmission rates) in use?
26.	Devices in use are Ex certified?
Additionally in case of PROFIsafe installations	
27.	No stubs are used?
28.	PROFIsafe certified devices only (safety and standard)?

### 2.2 Acceptance Measurements PROFIBUS RS-485

The second part of the assembly acceptance procedure is verification of the electrical function of the PROFIBUS cable. Please use a handheld device for this measurement.

Whichever method is used, the measurement results should be properly documented. The assembly acceptance checklist in the appendix is available as a template. The log can then be submitted to commissioning personnel.

Many handheld test tools have associated PC software which can be used to automatically document the measurement results.

Table 3 provides a checklist of measurements that should be made for acceptance.



In general, handheld devices are not suitable for use in plants where there is an explosion hazard.

## Assembly Acceptance

**Table 3: Checklist for Acceptance measurements for PROFIBUS RS485 cabling**

1.	Wiring test
	<p>No short circuit between data core A and B?</p> <p>No short circuit between data core A and shielding?</p> <p>No short circuit between data core B and shielding?</p> <p>Data core A intact?</p> <p>Data core B intact?</p> <p>Shielding is intact?</p> <p>Data cores not reversed (swapped)?</p> <p>Terminators on only at the segment ends (max 2 terminations per segment)?</p>
2.	Interface test
	<p>Voltage present for terminators on all interfaces?</p> <p>RS485 signal strength sufficient on all stations?</p> <p>CNTR signal present on the master?</p>
3.	Live List?
	All PROFIBUS stations are reachable at their address?
4.	Segment length measurement (cable type A)?
	<p>Maximum segment length at 9.6 kBit/s to 93.75 kBit/s: 1,200 m?</p> <p>Maximum segment length at 187.5 kBit/s: 1000 m?</p> <p>Maximum segment length at 500 kBit/s: 400 m?</p> <p>Maximum segment length at 1.5 kBit/s: 200 m?</p> <p>Maximum segment length at 3 MBit/s to 12 MBit/s: 100 m?</p>
5.	Minimum required cable length between PROFIBUS devices observed? (See the PROFIBUS Installation Guideline for Planning)

### ***Description of the acceptance process steps***

- Step 1: Wiring test

Using the measurement processes described in chapter 1, verify whether the wiring has been executed correctly.

- Step 2: Interface test

A handheld device can be used to check the PROFIBUS cable, and slave device interfaces. The following interface characteristics are verified:

- PROFIBUS signal
- Supply voltage for terminator
- CNTR signal (not all handheld devices)



For this, connect the handheld device to the respective PROFIBUS station. See the manufacturer's description of the handheld device for the precise procedure.

The supply voltage can also be checked with a multimeter. The measurement is performed between pin 5 (+5 V) and pin 6 (Earth) of the 9-pin sub-D connector.

- Step 3: Generate a live list

Check whether all PROFIBUS stations can be reached. Many handheld devices support this feature. Some programming devices with appropriate software also offer this possibility.

- Step 4

Using the measurement processes described in chapter 1, verify that the specifications for maximum permissible cable runs have been complied with.

- Step 5: Reflection test

Check whether there are reflections on the PROFIBUS with a handheld device. These can occur at defective connection points, or they can be caused by stubs or damaged PROFIBUS cable. If you are experienced in handling an oscilloscope, then you can also use this device as described in chapter 4.5.

### 2.3 Acceptance Measurements - PROFIBUS MBP (PA)

The PROFIBUS MBP (PA) wiring can be checked with a multimeter or installation tester. Chapter 5.2.3 describes how to do this. A checklist for the acceptance measurements for PROFIBUS MBP (PA) can be found in the Appendix. When using a multimeter for the acceptance measurement, the DC voltage on the PROFIBUS MBP (PA) cable must be measured. This should be at least 9 V and not more than 32 V at each station. A typical value for non-hazardous installations is 19 V. For intrinsically safe installations where there is an explosion hazard, the value should not be more than 13.5 V.



PROFIBUS MBP (PA) is often used in areas where there is an explosion hazard. Note that special regulations apply for plants where there is an explosion hazard. Speak with the plant operator before the acceptance measurement, to determine whether an acceptance measurement is possible, and which safety measures you must comply with in this case.

### **2.4 Acceptance measurements optical fiber**

#### **2.4.1 General**

In planning you cannot precisely calculate the quality of a signal transmission via an optical fiber. For example, signal transmission is weakened or attenuated through the optical fiber and the connections. Attenuation measurement performed after the installation has been completed is the only way to determine the extent of the losses (see section 1.5.1). The test can also determine whether the optical fiber was damaged when it was laid.

Because attenuation measurement requires expensive equipment and evaluation of the measurement results require specialized skills you should consider hiring a specialized company to perform the measurements. For this reason we do not discuss the measurement processes for optical fibers in more detail here. If you intend to purchase the appropriate measurement devices, then obtain advice on the necessary equipment and training from the manufacturer.

Please note that modern devices monitor the signal strength on the incoming FO cable and provide the corresponding diagnostic data. However, this is intended for operational monitoring only and is no substitute for the acceptance measurement.

#### **2.4.2 Measurement Results Damping Measurement**

If a specialized firm performs the measurements for you, then you will get a measurement log from that firm. In the measurement log you will find a measured value that shows you the extent of signal attenuation of the transmission path. The loss is normally shown in dB. The measured attenuation value should be less than the maximum fiber attenuation shown in Table 4.



## Assembly Acceptance

---

**Table 4: Maximum fiber attenuation - optical fiber**

	Single mode fiber optic	Multimode fiber optic	PCF-/HCS <sup>1</sup> - fiber	Synthetic fiber	
				Standard	In- creased
Typical wavelength	1320 nm	850 nm	660 nm	660 nm	660 nm
Max. fiber attenuation	5 dB	6 dB	4 dB	6 dB	11.5 dB
*1 PCF and HCS are trademarks					

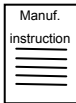

Please refer to the manufacturer's information for the attenuation of the fiber used.



---

## **3 Commissioning / Acceptance**

### **3.1 Bus test**

After installation, the PROFIBUS network must be commissioned. The installation acceptance documentation should be submitted to you for commissioning. If this documentation has been submitted, then additional testing of the PROFIBUS assembly is not required. If this documentation is not present, then you should perform the assembly acceptance, as described in chapter 0, together with the installer.

### 3.2 Commissioning the bus

The commissioning process is divided into eight steps:

Step 1: Visual inspection

Step 2: Acceptance measurements

Step 3: System configuration

Step 4: Verify the address setting of PROFIBUS stations.

Step 5: Commission masters and slaves

Step 6: Test signal inputs

Step 7: Test signal outputs

Step 8: Create acceptance checklist

Steps 1 and 2 are part of the assembly acceptance and should already be completed. Steps 3 to 8 are now explained in more detail.

#### 3.2.1 System configuration (step 3)

Configuration of the PROFIBUS devices generally involves using a software configuration tool to describe your PROFIBUS system. Because the programming device and software varies from manufacturer to manufacturer, we cannot give detailed instructions on how this stage is carried out. Before you start with system configuration you should be familiar with the operation of the programming device and the associated software. Here we list a few points that you should be aware of.

##### Data rate

The PROFIBUS data rate is an important consideration. Higher bit rates yield faster cycle times, however high bit rates require strict adherence to wiring guidelines, as the requirements on the cabling quality considerably increase with higher data rates. In practice it is recommended that you use the lowest bit rate that can achieve the required cycle time. The bit rate is set on the PROFIBUS master devices; most modern PROFIBUS slaves do automatically adapt to the master bit rate. Only occasionally do you need to set the bit rate on a slave device.

Ensure that you set the correct bit rate for all PROFIBUS stations requiring this. If the transmission speed is set incorrectly then communication will not be established.

### Device description files

PROFIBUS stations are integrated in a project via device description files. This involves a standardized file type in which PROFIBUS station characteristics are described. The device description file is generally abbreviated as "GSD file". GSD stands for "General Station Description". The GSD file for a device contains standardized information on the characteristics and options available for that device. GSD files often incorporate text which appears on the PC screen in the configuration tool. The language used for the text in GSD files is not specified (normally English or German are used). Specific language versions of GSD files are often available and are designated by a language specific filename extension. If possible, you should use the appropriate device description file for your chosen language. The following file types are possible:

- \*.gse for English
- \*.gsf for French
- \*.gsg for German
- \*.gsi for Italian
- \*.gsp for Portuguese
- \*.gss for Spanish

In addition the general file type "\*.gsd" is also possible; this file type is created in English. It is essential that the correct GSD files are used for the devices on your PROFIBUS system. Each type of PROFIBUS device has a unique identification (ID) number. The ID number is assigned by the PROFIBUS User Organization and is unique worldwide for each type of PROFIBUS device. The GSD file must correspond to the ID number of the configured device. The process of selecting the GSD file is made simple because the GSD file name contains the ID number. A GSD file name comprises of up to 8 characters. The first four characters indicate the name of the manufacturer of the PROFIBUS device; the last four characters are its ID number expressed in hexadecimal.

For example:

“SIEM8027.GSD” – A generic file for Siemens device ID 8027

“WAGOB760.GSE” – An English language file, for WAGO device ID B760

Often when using devices from different manufacturers, the GSD files from the various manufacturers' devices must be imported into the configuration tool. Quite often this simply means copying the GSD file into the correct directory on the PC or notebook being used for configuration.

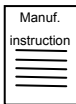

Please see the configuration program manual or help file to learn how to import a GSD file.

The current GSD files of the PROFIBUS stations used are available from the manufacturers.



When using the GSD files, ensure that the GSD file version matches the version of the PROFIBUS station. Otherwise it is possible that some functionality will not be available.

### Addressing

It is essential that the address of every PROFIBUS station is correctly set in the configuration tool. If an incorrect address is set, then the master will not be able to communicate with the station. You should ensure that the addresses used in the configuration tool agree with the planned addresses of the PROFIBUS stations. In addition, you should check that the addresses set on the physical PROFIBUS stations matches with the addresses in the project plan.

### Bus parameters

Bus parameters are used to set the details of the timing within a PROFIBUS cycle. There are many parameters involved, however normally the system standard settings can be used.

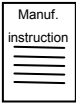

If you need to change the bus parameters, please read the manufacturer's instructions relative to projecting software, and to the PROFIBUS stations used.

### Save the project

Once completed, the system configuration should be saved on suitable data media (USB stick, CD) and submit it to the customer as part of the acceptance process. In addition a back-up copy should also be stored safely. Thus the information will also be available to you in the future, i.e. in the event of malfunction, or for service.

### 3.2.2 Verifying PROFIBUS station addresses (step 4)

The address of a PROFIBUS station can be set in one of three ways:

- A local switch on the device (binary dip switch or rotary switch).
- Software setting of device address over the PROFIBUS network using a configuration tool (called a Class-II master).
- Some devices may use special software and a serial link or hand-held tool to set the device address (e.g. some masters, drives or HMI devices).

PROFIBUS stations which incorporate setting of the address over PROFIBUS are often delivered with a pre-set address of 126. It is important that no two devices have the same address on the network otherwise communication is impossible. Consequently, either the addresses of such stations must be correctly set before the station is connected to the bus, or only one station must be connected to the bus at a time and its address must be changed before connecting the next station.

Accordingly many PROFIBUS stations would have the same address if you do not change the pre-installed address. Consequently, check the addresses of the PROFIBUS stations prior to commissioning.



Only one PROFIBUS station with the address 126 can be connected at a time. The address must be changed before another station can be added.



Incorrect address setting can be difficult to diagnose, particularly when duplicate addresses are set. Consequently, checking of addresses should be carried out prior to commissioning. Hand held tools can be used for this (see chapter 1.3).

### 3.2.3 Commissioning PROFIBUS stations (step 5)

After you have configured the master system, you can commission the PROFIBUS.



It is good practice to use separate power supplies for the PROFIBUS stations and for their outputs. This allows the PROFIBUS network to operate without danger of actuating plant equipment such as drives, heating elements etc. For safety reasons, the powersupplies for the PROFIBUS station outputs should be switched off when commissioning a PROFIBUS network.

First verify that all PROFIBUS stations are supplied with voltage. See the manufacturer's description for the supply voltage required by each PROFIBUS station. The configuration can be downloaded to the master station(s).

Master stations have four different modes of operation:

- Off-line – No interaction with the bus.
- Stop mode - No interaction with the configured slaves but master will take part in the bus communication.
- Clear mode – The master goes into data exchange with the configured slaves but all outputs will be in their fail-safe state (normally off).
- Operate mode – Full communication with all configured slaves using output data derived from the plant control program.

Placing the master(s) into clear or operate mode will establish communication between the master(s) and slave stations. After a short time, all PROFIBUS stations should signal that they are ready for operation. The operating status of the master can normally be read via the configuration software using the programming device. Many PROFIBUS slave stations are provided with an LED indicating “bus fault” (BF). Sometimes a status display is provided. When the master is in clear or operate

mode the slave stations should not be indicating a bus fault. Any stations that do show a bus fault are not communicating properly and will need further investigation.

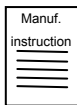

Please refer to the manufacturer's description for the meaning of the slave device status displays.

### 3.2.4 Testing the Signal Inputs (step 6)

The next step is to test the signal inputs of the slaves. To do this, first check the voltage supply for the sensors. The sensor supply voltage will be specified in the sensor manufacturer's information.

Next you should activate the sensor. This can sometimes be done manually or sometimes by simulation of the process input on the sensor. Trace the signal all the way back to the master. The LEDs on the PROFIBUS station where the transducer is connected, and the I/O map in the master, are available to help you do this. The I/O map can often be read on the programming device using the configuration or programming software. Some sensors also have their own display.

### 3.2.5 Testing the Signal Outputs (step 7)

The signal outputs can next be tested in a similar way to the inputs. However you must first check that it is safe to activate the outputs and that appropriate safety precautions have been taken.



Danger – activation of signal outputs may cause motors to start and actuators to move. You must take appropriate safety precautions before activating outputs.

After checking that it is safe to apply the output control voltage, the output supply should be switched on. A check should be made on the value of the control voltage. The output supply voltage will be specified in the manufacturer's information. Each signal output can now be activated or forced manually via the configuration or programming software. Trace the signal from the master all the way to the signal output. Check the IO map in the master, the LEDs on the slave, and the output

itself. Analog signal outputs can also be forced to a particular value and checked using a multimeter to measure output voltage or current.

- It is not unusual to find that the output supply voltage fails when switching on many outputs simultaneously. This can be caused by poorly specified power supply which cannot supply the required current when all outputs are activated. A check should be made on the control voltage with all outputs switched on so that the maximum current is drawn. If the voltage dips when the outputs are switched then a power supply with a higher current limit should be used.

### 3.2.6 Create acceptance checklist (step 8)

The last step is to create an acceptance checklist. With this checklist you can document that the acceptance was successful. In the Appendix you will find commissioning checklist and acceptance checklist templates.



---

## 4 Troubleshooting

### 4.1 Introduction to troubleshooting

This chapter is designed to help you locate errors in PROFIBUS cabling. The first steps have already been discussed in chapter 1. Here we discuss other possibilities that require somewhat more experience than is required for simple PROFIBUS diagnostics. The following possibilities are available to you:

- Checking the cabling infrastructure
- Measurements with a bus monitor
- Diagnostic telegram interpretation
- Oscilloscope measurements
- Optical fiber measurements

Additional troubleshooting information is included in the “PROFIBUS Profile Guideline – Part 3: Diagnosis, Alarms and Time Stamping, Version 1.0 (July 2004)” from the PI”.

### 4.2 Checking the Cabling Infrastructure

Checking the cabling infrastructure should be one of your first troubleshooting steps. Errors can creep in here, for example, if the routing of the PROFIBUS cable has been changed. The potential for errors when extending or modifying a network is particularly high. For example, exceeding the maximum segment cable length or exceeding the maximum permissible number of PROFIBUS stations in a segment. Stub lines, particularly at high transmission speeds (above 1.5 MBit/s) also represent a problem for PROFIBUS RS485 transmission technology and should be avoided. Spurs are permissible for PROFIBUS MBP (PA), however, only within a limited length.

Check the cabling structure for the following points:

- Do the cabling structures adhere to the planning?
- Do the maximum permissible segment lengths comply with the planning?
- RS-485 transmission technology: It is highly recommended to avoid any stub lines.
- MBP (PA) transmission technology: Were the maximum number of spurs and the associated spur lengths within specification according to the planning?
- Was the PROFIBUS network installed according to the planning?
- Were any changes made during the installation and have these changes been incorporated into the documentation?
- Were changes made to an existing system?
- Was the cabling structure maintained after the changes?
- Does the maximum permissible segment length still comply with the specification after the changes?
- Were the changes documented?

In addition to testing the actual cabling, you should also test the cabling of the equipotential bonding. An error in the equipotential bonding can result in communication malfunctions. Since errors in the equipotential bonding are very difficult to locate, you should check all equipotential bonding connections.

### 4.3 Measurements with a Bus Monitor

A bus monitor is a device that can record and display the data traffic on the PROFIBUS network. Bus monitors provide an effective way of observing the communications of the PROFIBUS stations. However, analysis of the recorded information requires experience. Many modern bus monitors provide some telegram decoding which makes them easier to use. However, detailed analysis of the communication will require a specialist. Modern bus monitors also incorporate communication statistics which can help to diagnose and locate intermittent faults which are very difficult to find in any other way.

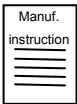

Read the description provided by the manufacturer for information on operating the bus monitor.

A PROFIBUS monitor should have the following features:

- Message capture and display with the ability to “trigger” on particular telegrams or conditions.
- Real-time operation at the required bit-rate without “missed telegrams”.
- Message filtering to allow display of selected telegrams.

Other useful features include:

- “Live list” overview showing all devices that are taking part in communications.
- Decoding of the telegrams.
- Oscilloscope triggering facility allowing the capture of the transmitted waveform from a particular slave.
- Communication statistics showing numbers of corrupted and/or repeated telegrams.

A good bus monitor can help to diagnose and locate a wide variety of faults, however training is essential. Certified PROFIBUS Engineer Courses, which cover the use of a bus monitor, interpretation of telegrams and fault finding procedures are available in many countries. These are publicized on the PROFIBUS International web site, [www.profibus.com](http://www.profibus.com).



### 4.4 The diagnostic telegram

Potential faults are not limited to the PROFIBUS network. For example, power supply, I/O wiring and sensor/actuator faults can also occur. PROFIBUS provides extensive diagnostics that can help to diagnose and locate many faults. When diagnostic information is available in a PROFIBUS device, the device sets an error bit during cyclic data exchange to prompt the master to request this diagnostic information. The PROFIBUS master then reads the diagnostic data and saves them separately for each device. When and how the diagnostic information is indicated to the user depends on the control unit to which the PROFIBUS master is allocated.

The diagnostic buffer of a slave may contain several parts:

- 6-bytes of standardized diagnostics provided by every PROFIBUS slave.
- An optional device-dependent diagnostics, which are manufacturer dependent, but may be defined in the device manual or GSD file.
- An optional module-related diagnostics, that indicate which, if any, modules have a problem. The structure of the module related diagnostic block, if provided, is described in the PROFIBUS standard.
- One or more optional channel-related diagnostic blocks, which indicate which channels on particular modules, have a problem. The channel-related diagnostic block also provides a code which describes the details of the fault. Channel-related diagnostics are described in the PROFIBUS standard.

The standard PROFIBUS diagnostics are always present as the first 6-bytes of the diagnostic telegram or buffer. The other blocks are optional, and may appear in any order and can even be repeated for different faults on different modules. For example, a particular diagnostic telegram may contain 6-bytes of standard diagnostics followed by a module-related diagnostic block, followed by several channel-related blocks, one for each channel fault.

Many PROFIBUS tools are available that can show the diagnostic buffer. These tools can include the following functionalities:

- Master configuration software which has on-line functionality.
- Class-II masters.
- PROFIBUS bus monitors.

Some of these tools will also interpret the diagnostics for you, according to the PROFIBUS standard, or as described in the device GSD file. You can also interpret the diagnostics manually. However, this requires considerable experience and skill. Certified PROFIBUS Engineer Courses, which cover the use of an analyzer, interpretation of diagnostics are available in many countries. These are publicized on the PROFIBUS International web site, [www.profibus.com](http://www.profibus.com).

Additional information on the diagnostic telegram is provided by the following document from the PROFIBUS User Organization:

PROFIBUS Profile Guideline – Part 3: Diagnosis, Alarms and Time Stamping, Version 1.0 (July 2004).

### 4.5 Oscilloscope Measurements

Usually, sufficient results can be obtained by measurements with a bus monitor. It is recommended to verify the signal waveform with an oscilloscope only if troubleshooting with a bus monitor should be ineffective. Oscilloscope measurements on PROFIBUS require a certain level of experience. Consequently, the measurements should only be performed by experts.

Oscilloscope measurements are a very effective means of troubleshooting PROFIBUS. With a little practice different statements about errors and signal quality can be derived from the signals displayed. This chapter shows which characteristics the oscilloscope must have, which auxiliary aids are practical, and what you can measure with the oscilloscope. In addition typical signal waveforms are shown in some figures in this document.

#### 4.5.1 Technical Prerequisites

The following characteristics require an oscilloscope for measurements on the PROFIBUS.

Design:	Digital storage oscilloscope
Bandwidth	100 MHz
Channels:	2, potential separated to each other and against the device ground (network connection)
Trigger:	Internal + external
Coupling type:	DC

Battery-powered oscilloscopes are well suited. Due to the handy format and independent power supply they offer a high level of mobility in the system.

The potential separation between the two input channels and against the device ground is particularly important. Separation of the two channels ensures that they do not affect each other. It is just as important that both channels are also potential

separated from the device ground. If this is not the case, then an unintentional or intentional connection of a channel ground to a live core can result in a short circuit. For measurements on the PROFIBUS, often the channel reference potential is connected to one of the two data lines. Measurement would not be possible without a potential separated oscilloscope, since the signal is tapped on ground on the data line. This is particularly undesirable for measurements during system operation and must be avoided. Connecting the reference potential to the data line would result in a communication breakdown. However, you can avoid this by measuring both signals separately, and then indicate the signal difference. In this case potential separation of the two channels is not required. However, proceed very carefully in this case. There is a risk of short circuit if you connect the measurement cable incorrectly. Alternatively, you can use a differential probe.

Another useful function is a multimeter integrated in the oscilloscope. In this case you can save one device.

Modern digital oscilloscopes offer an integrated RS-232 interface or a USB interface for connecting to the PC. Thus measurements performed can be saved and documented with the PC.

### 4.5.2 Measurement Aids

Use a 9-pin Sub-D plug or an appropriate M12 junction, on which you can tap the signals, as measurement aid. The following drawing shows which signals can be measured on which pins.

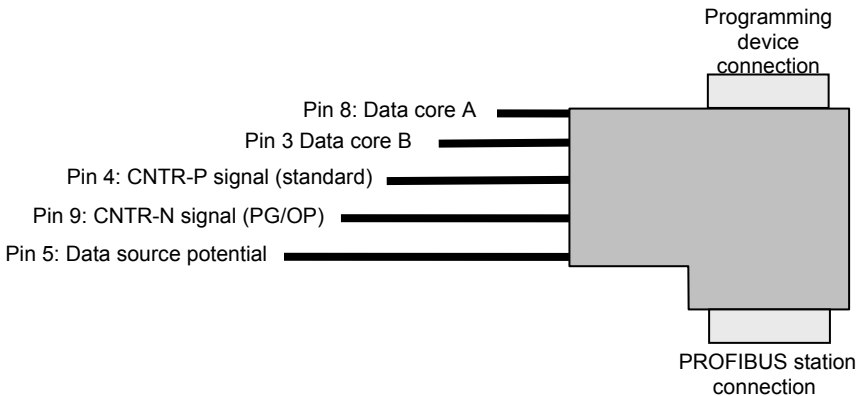

**Fig. 3: Measurement plug oscilloscope measurement**

A PROFIBUS plug with a programming device connection is best suited for this measurement aid. This is primarily helpful if the PROFIBUS structure does not have a programming device connection. In this case you can then insert the measurement plug between the PROFIBUS station and the PROFIBUS cable.

For some PROFIBUS stations, such as programming devices or operation panels, the CNTR signal is not routed out of standard pin 4. In this case pin 9 is used on these PROFIBUS stations. For some operation panels the CNTR signal must also be activated, for example through DIP switches. Read the operating manual in this case or ask the manufacturer.

### 4.5.3 Measurement PROFIBUS RS485

The important thing is that the measurement must be performed on the interface of the respective PROFIBUS station. If only individual PROFIBUS stations show errors, then it is best to start with the measurement on these stations.

You should perform the following measurements:

- Data core B against data line A

## Troubleshooting

---

Measurement of the data signals of data line B against data line A shows you the actual signal waveform on the PROFIBUS. Both cores are used for PROFIBUS data transmission. The signals are transmitted concurrently on both cores. However, the signal on data line B is transmitted reversed to data line A. The actual signal is a result of the voltage differential between B and A. This type of signal transmission has the advantage that noise affecting both data lines uniformly does not have an effect on the transmitted data telegram. Through differential transmission, noise on one core is subtracted from the noise on the other core. Thus no there is no noise voltage remaining in the actual data telegram.

There are two ways to perform the measurement. You need an oscilloscope that can subtract two channels from each other as the first possibility. This should be possible with most digital oscilloscopes: Adjust the oscilloscope as follows:

Displayed signal: Voltage B - voltage A

If you have an oscilloscope with isolated channels, you can also measure the differential voltage B - A directly. Connect the ground terminal of one channel to data line A, and the signal terminal of the same channel to data line B. This measurement is more precise than the subtraction of the voltage B-A, however, it has two disadvantages:

1. You must have an oscilloscope with potential separation.
2. Due to its structure, the ground cable acts like a spur that is only connected to one data line. This can cause signal distortion at high transmission speeds. Usually this does not cause problems. However, you should bear this in mind.

The voltage differential between high level and low level measured between B and A should be between 4 V and 7 V. The positive and negative voltage value should be approximately the same size. The difference between the two values in practice is approximately 0.5 V. The quiescent level should be 1 V.

Many PROFIBUS stations supply the so-called CNTR-P signal. The CNTR-P signal has a logical high level (approximately 3 V to 5 V) while the PROFIBUS station is transmitting. This is helpful if you want to examine a certain PROFIBUS station. Use the rising edge of the CNTR signal as trigger signal for the oscilloscope. Use either the external trigger input (advantage: second channel

---

## Troubleshooting

---

remains free for use) or the second channel (advantage: CNTR signal itself is visible) of the oscilloscope with this signal. Thus you can observe the transmission of the respective PROFIBUS station.

Through the CNTR signal you can also detect the associated telegrams of masters and slaves (passive). The master's telegram is namely the last telegram that was on the PROFIBUS prior to the slave's telegram. If you measure directly on the master, the CNTR signal will be transmitted concurrently with the telegram.

For the measurements on data line A, on data line B, and between data line B and data line A, you should set the input voltage level to at least 1 V/division. Less resolution is not effective, details would get lost. For the time division you should first select a low time resolution. You should be able to see several telegram packets. Thus you can better detect asymmetries in the signal or EMC interference. Take a second measurement with finer time resolution so that you can see only one bit or just a few bits. This makes it possible to see details in the edges.

- Measure data line A against data ground
- Measure data line B against data ground

With the measurements, data line A against ground, and data line B against ground, you can check the signals on the individual lines and uncover errors like defective bus drivers. However, you must perform the measurements directly on each PROFIBUS station. Due to the needed effort, you should only perform this measurement if you have detected errors when measuring B against A.

Ensure that the data grounds of the individual PROFIBUS stations are not connected to each other via the PROFIBUS cable. Since you must perform the individual measurements of the data lines against the data ground, only the signal sent from the PROFIBUS station is correctly displayed. You can detect this by the simultaneous transmission of the CNTR signal through the PROFIBUS station.

The important thing for these measurements is that you execute them against the data ground of the interface. A measurement against the device ground

---

## Troubleshooting

---

usually will not be successful, because usually potential separation is present in PROFIBUS stations. You should be able to measure the following voltages on the interface:

- Quiescent voltage: Data core A: app. +2 V
- Quiescent voltage: Data core B: app. +3 V
- Transmission state Minimal voltage data line A: app. +1 V
- Transmission state Maximum voltage data line A: app. +4 V
- Transmission state Minimum voltage data line B: app. +1 V
- Transmission state Maximum voltage data line B: app. +4 V

For newer devices the maximum voltage on the data lines can be somewhat higher due to more powerful bus drivers. The minimum values and maximum values however, should be similar on both data lines. If this is not the case, then one of the two bus drivers could be defective.



Due to potential shifts it may be the case that the signals are shifted on the data lines by a positive or negative offset voltage. This can cause interferences in telegram traffic. The offset voltage on the data lines can be a maximum of +12 V or -7 V. Higher offset voltages may destroy the bus drivers.



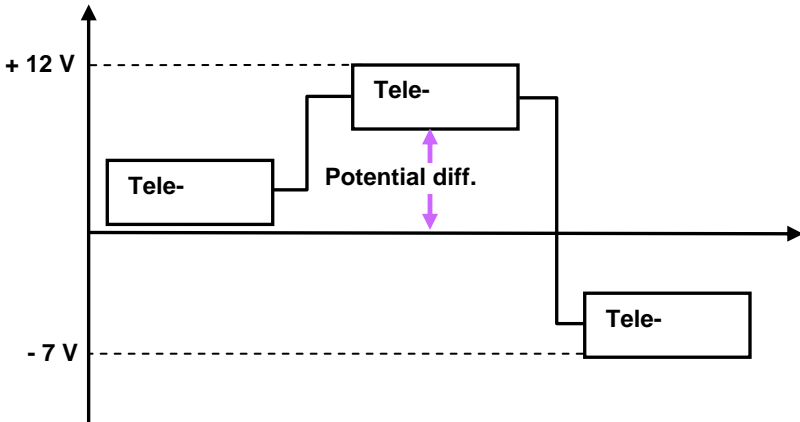

**Fig. 4: Potential shift at signals**

Due to potential shifts it may be the case that the signals are shifted on the data cores by a positive or negative offset voltage. This can cause interferences in telegram traffic. The voltage on the data cores can be up to +12 V or -7 V. At higher values the receiver subassemblies of the PROFIBUS stations can be destroyed.

Fig. 5 shows the ideal form for a PROFIBUS signal.

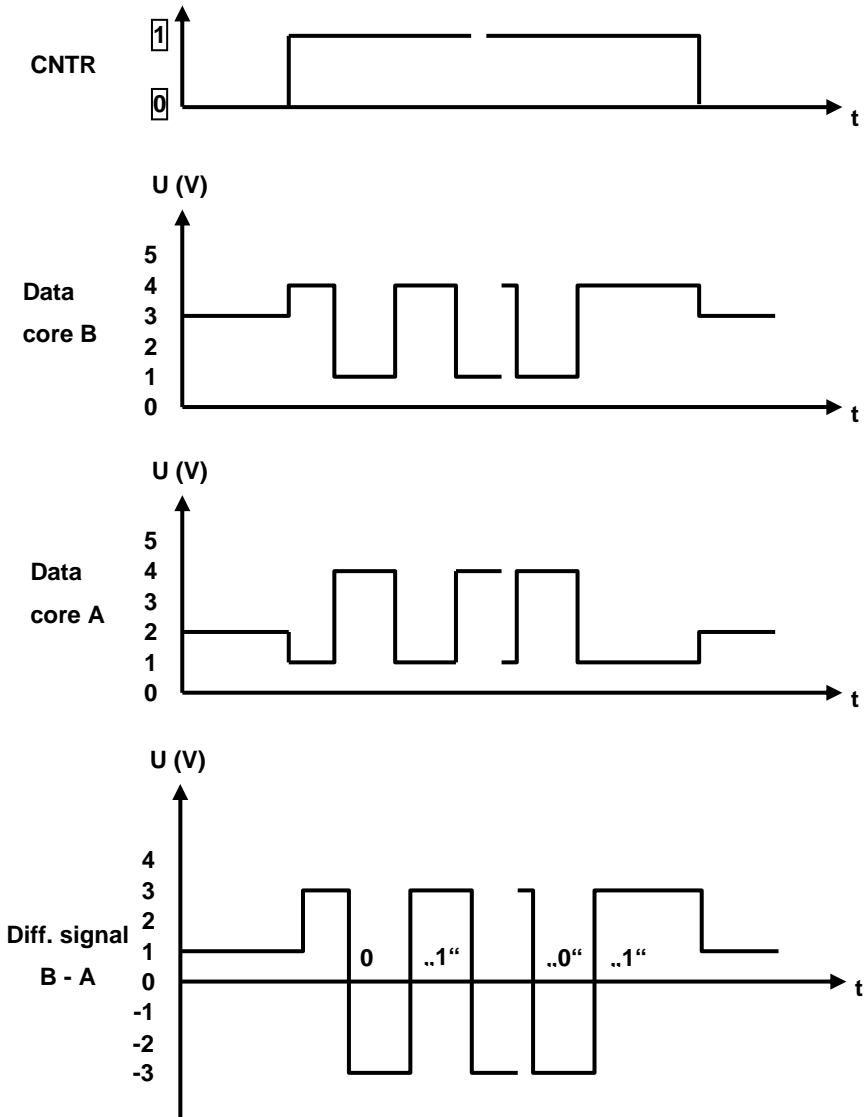

Fig. 5: Ideal signal form PROFIBUS RS485

The Fig. 5 shows you the ideal form of the PROFIBUS signal, in practice the signal waveform will never look this ideal. The Fig. 6 shows you an example of what the signal waveform of PROFIBUS signals can really look like.

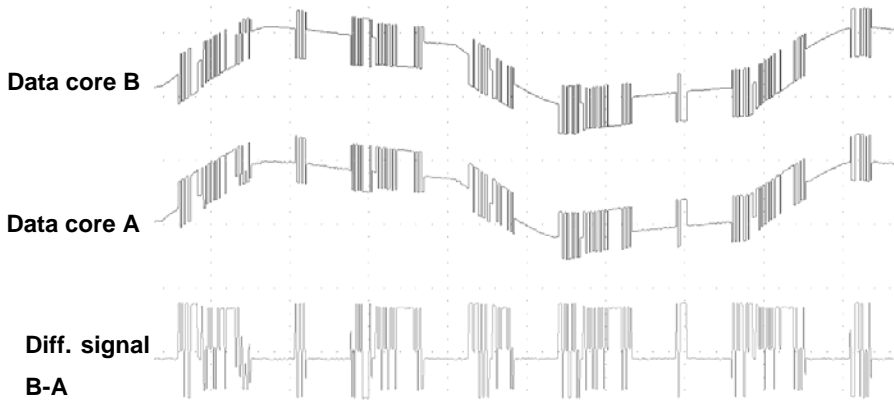

Fig. 6: Measurement PROFIBUS RS-485

### 4.5.4 Typical Signal Waveforms

In this chapter typical signal waveforms are shown based on some figures. The figures shown always represent the signal resulting from the measurement "B-A".

#### ***PROFIBUS cable too long***

Cable that is too long generally functions like a condenser. It changes the signal form. The result is that for a square wave signal the rising edge is rounded (e-function). This effect is more pronounced the longer the PROFIBUS cable.

If the signal is changed too drastically then it may be the case that the receiver cannot correctly recognize the signal. This is why the signal should have reached the full voltage level after 50% of the bit period, at the latest. This ensures good noise immunity even in the presence of other interferences.

Adjust the oscilloscope for this measurement in such a manner that you can only observe one to two bits and their edges.

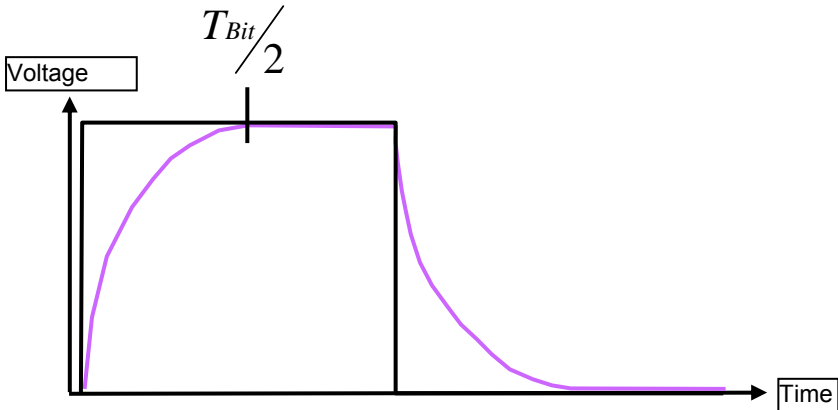

Fig. 7: Signal waveform for PROFIBUS cables that are too long

### ***Non-Connected PROFIBUS Plugs***

Another error source are PROFIBUS plugs that are inserted in the PROFIBUS cable, but are not connected to any PROFIBUS station.

To reduce signal reflections caused by spurs at high transmission rates ( $\geq 3$  MBit/s), inductors have been integrated in the PROFIBUS plugs. If a PROFIBUS station is not connected to a PROFIBUS plug, then the open connector in conjunction with the inductor generate signal interference. The interference should not be greater than 0.5 V.

The following figure shows what this kind of interference looks like.

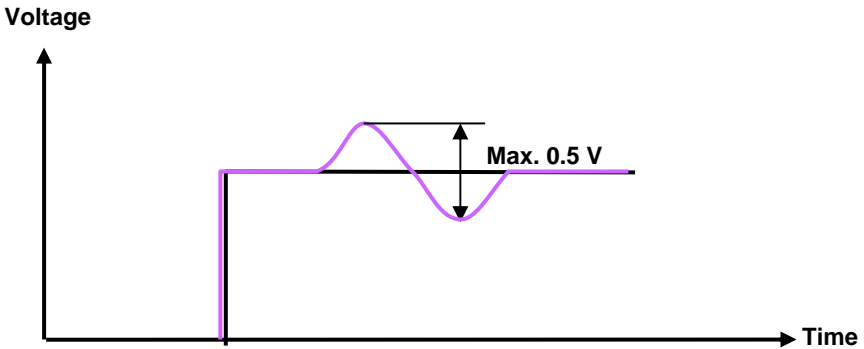

**Fig. 8: Signal waveform for non-connected PROFIBUS stations**

Adjust the oscilloscope for this measurement in such a manner that you can only see one to two bits and their edges.

### ***Defective Bus Terminator***

For the bus connection two types of errors can occur, both of which cause a signal reflection. The reflection strength depends on the error.

For the one error, too many terminators are switched on. Thus approximately 1/3 of the signal is reflected and is turned by 180° relative to the original signal. It then runs back on the PROFIBUS cable and can encounter the next sent telegram. The two signals are overlaid at the crossing point. If the signal waveform of the two signals is juxtaposed, the level is reduced. If the signal waveform is in the same direction then the levels are added.

The other error is a missing terminator. In this case there is also a reflection. However, the reflection is not turned 180° relative to the original signal. The signal returns in full height. If the reflected signal encounters a new data signal, then it may be the case that both signals cancel each other out, or a double high signal will occur. A break of the two data lines produces the same effect. In Fig. 9 and in Fig. 10 the possible signal waveforms are shown.

The signals show a step-like waveform when the telegram is overlaid with the reflection. The waveform can be different depending on measurement location, and cable run. Cable telegrams and reflection meet at different points, due to different signal start times on the PROFIBUS.

---

Too much terminator resistance

Original signal

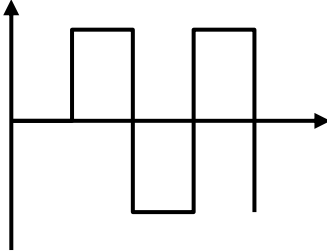

Reflection for too much switched-on terminator resistance

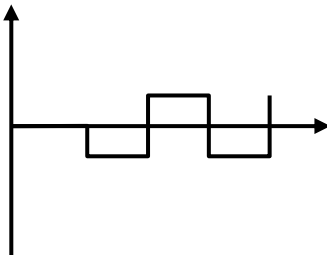

Overlaid signal (original signal + reflection) for too much switched-on terminator resistance

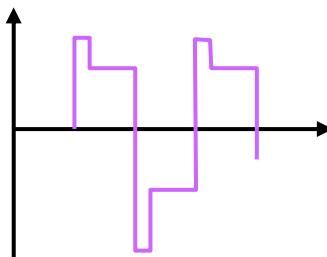

**Fig. 9: Too much terminator resistance**

## Missing terminator

Original signal

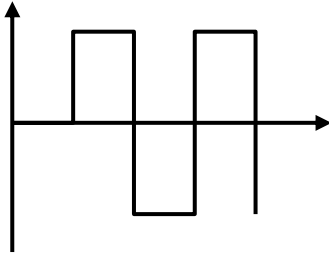

Reflection with missing terminator

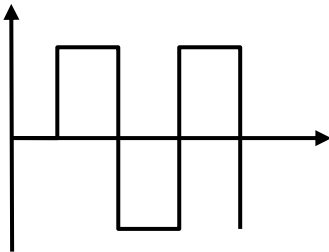

Overlaid signal (original signal + reflection) for too little terminating resistance

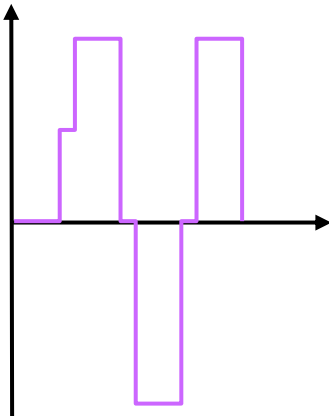

**Fig. 10: Missing terminator**

### 4.5.5 Measurements PROFIBUS MBP (PA)

The data signal on the PROFIBUS MBP (PA) is generated via current modulation. This makes it possible to supply PROFIBUS stations with energy and data via the same two cores.

Measuring the signal is not always easy with PROFIBUS MBP (PA). Some PROFIBUS MBP (PA) stations are encapsulated or drip molded for security reasons. Moreover, PROFIBUS MBP (PA) stations are often directly connected or connected via an M 12 plug connector; consequently, measurement is primarily possible only on the terminals of the signal coupler, or on the PROFIBUS MBP (PA) devices. You should perform two measurements to verify the signal on the PROFIBUS MBP (PA). With the first measurement you detect the direct current portion of the signal voltage with which the PROFIBUS MBP (PA) device is supplied. For this you set the oscilloscope on measurement type "DC", Adjust the vertical division (voltage) so that you can easily identify the signal on your screen. Select a very low resolution for the horizontal division (time). At this measurement the waveform over a certain period is more interesting than the details.

In plants where there is no explosion hazard voltage should be a maximum of 32 VDC. A typical value is 19 VDC. For plants where there is an explosion hazard the maximum direct current is 13.5 VDC. The voltage that the feed device must supply is provided is specified by the device description. Perform the measurement directly on the feed device, and if possible on the most remote PROFIBUSMBP (PA) station.

You should measure the above-mentioned voltages on the bus power supply, which is often integrated in the DP/PA Linking device. If the voltage is lower, then this indicates a defective voltage supply, or too many stations on the PROFIBUSMBP (PA) cable. You must measure at least 9 VDC at the PROFIBUSMBP (PA) station. A lower voltage is not sufficient to supply the PROFIBUSMBP (PA) stations. If the direct current is too low only on the most remote PROFIBUSMBP (PA) station, then the PROFIBUSMBP (PA) cable could be too long.

Check the alternating voltage in the second measurement. This is the actual data signal. Theoretically the difference between the maximum positive and the maximum negative alternating voltage is 900 mV. In practice the value is between



## Troubleshooting

800 mV and 1000 mV. A higher value indicates a missing bus terminator. On the other hand a lower value indicates too many bus terminators. Set the oscilloscope to measurement type AC for the measurement. Select approximately 200 mV/division for the vertical division (voltage). For the horizontal division (time) you should set approximately 20  $\mu$ s/division.

The figures below show the signal in the ideal case, as well as with too few and too much terminating resistors.

Ideal signal

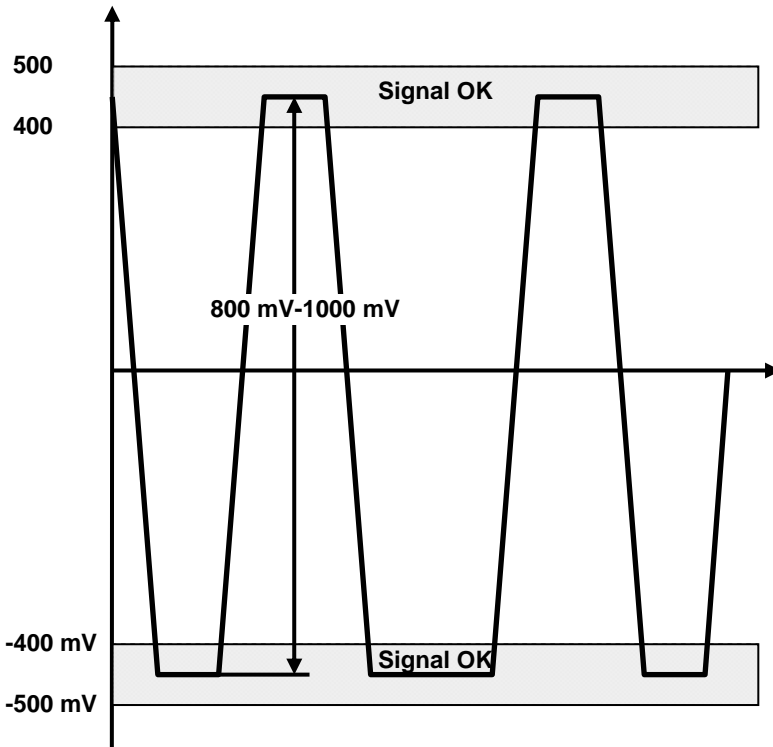

Fig. 11: Ideal signal form PROFIBUS MBP (PA)

## Troubleshooting

Missing bus terminator —

Too many bus terminators —

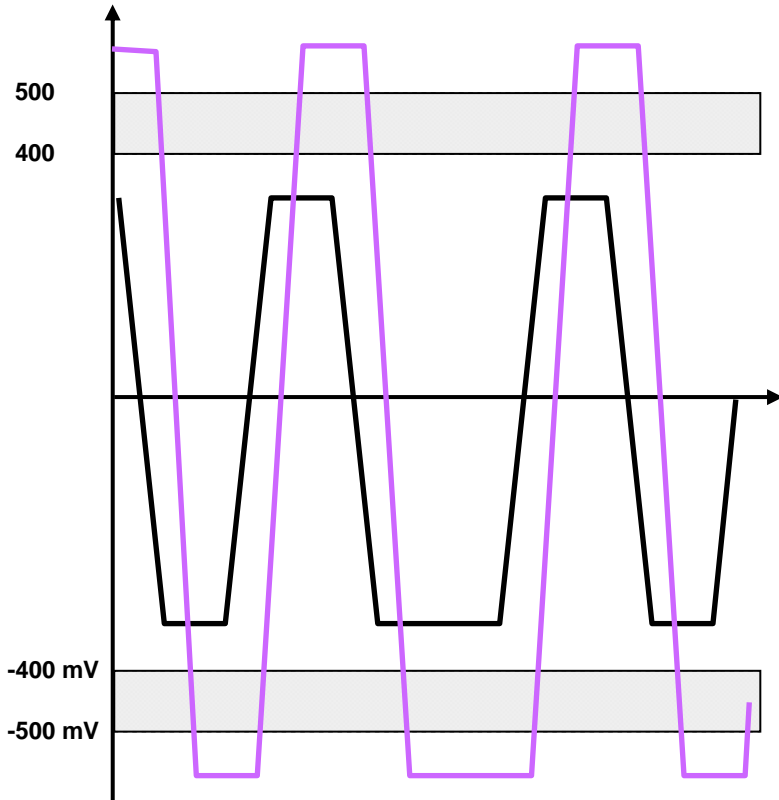
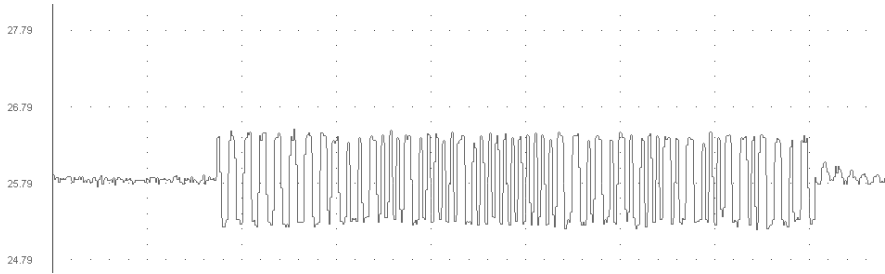

Fig. 12: PROFIBUS MBP (PA) with defective bus terminator

In practice you will never encounter an ideal signal form as shown in Fig. 11. In Fig. 13 is shown of what a data telegram can really look like on the PROFIBUS MBP (PA).



**Fig. 13: Measurement PROFIBUS MBP (PA) (1 telegram)**

## 4.6 Optical fiber measurements

The OTDR measurement process (OTDR = Optical Time Domain Reflectometer) is particularly interesting for troubleshooting. Based on the measurement results a specialist can not only determine the presence of an error, but also determine the location of the error.

To do this, the OTDR-device transmits a signal into the optical fiber. Portions of the signal are reflected at connectors or at defective points (see Fig. 14: OTDR measurement principle).

The device measures the strength of the reflected part of the signal, and how much time elapses from signal transmission until the reflection is received. The measurement results allow you to identify the location of the damage.

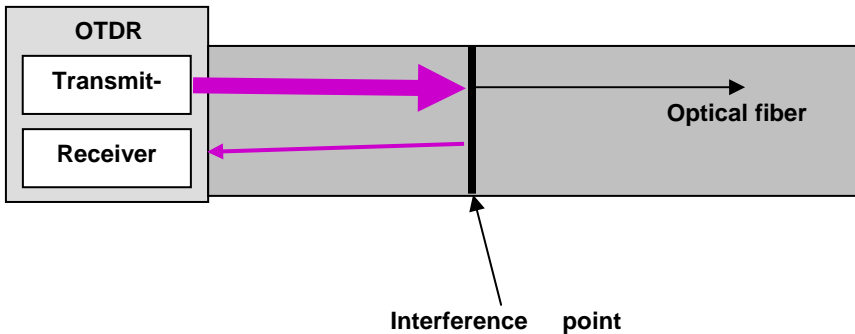

**Fig. 14: OTDR measurement principle**

This process is particularly demanding, as the results are usually displayed in graphical format. The operator needs to interpret the results. You should use this process only, if you have experience with it. Otherwise let a specialist perform the measurements. If, however, you still need to use an OTDR measurement device, then it is recommended to sign-up for a training course.

---

## **5 Annex**

## **5.1 Commissioning/Acceptance Checklists**

## Annex

### Checklist for visual inspection PROFIBUS cabling RS485 / MBP (PA) / Fiber optics

System		Segment name
		Transmission speed
Assembly acceptance performed by		
Comments		
<b>Visual inspection</b>		
<b>OK</b>	<b>Not OK</b>	
		1. Cable laid according to plan?
		2. Cable type according to plan?
		3. Max. length of stubs not exceeded? (Only relevant for PROFIBUS MBP (PA), DP does not allow for stubs.)
		4. Connectors available according to plan (M12, Sub-D9, etc)?
		5. Minimum spacing between cabling has been complied with, or metal partitions have been inserted?
		6. Recommended minimum cable length of 1 m between PROFIBUS devices observed? (See the PROFIBUS Installation Guideline for Planning)
		7. PROFIBUS cable in order (no damage)?
		8. Bend radii specification observed?
		9. Cable crossings executed at right angles?
		10. Only two terminating resistors inserted (on both cable ends)?
		11. Guaranteed power supply for terminating resistors (even in case of emergency stop)?
		12. Sharp edges have been covered or removed?
		13. Safeguards against mechanical damage present at hazard points?
		14. At least one plug is present with programming device connection?
		15. Strain relief fixtures attached?
		16. All Equipotential bonding points available according to plan?
		17. Shielding is applied to the PROFIBUS stations, and connected to the equipotential bonding?
		18. Shielding on the cabinet entrance is connected with the equipotential bonding?
		19. Cable trays grounded?
		20. Subassemblies used in accordance with the structure plan (24 V/230 V subassemblies not reversed)?

## Annex

		21. Transmission speed and PROFIBUS address are set according to structure plan?			
		22. Channels not required are switched according to manufacturer's description?			
		23. Proper measurement range selected on the analog subassembly (current/voltage)?			
Additionally in case of RS485-IS segments (Ex environment)					
		24. Only isolating repeaters used?			
		25. Transmission rate limited to 1.5MBit/s?			
		26. No connectors with discrete inductors (e.g. 110nH such as required for high transmission rates) in use?			
		27. Devices in use are Ex certified?			
Additionally in case of PROFIsafe installations					
		28. No stubs are used?			
		29. Certified devices only (safety and standard)?			
<table border="1" style="width: 100%; border-collapse: collapse;"> <tr> <td style="width: 25%; padding: 5px;">Date</td> <td style="width: 45%; padding: 5px;">Installer signature</td> <td style="width: 30%; padding: 5px;">Commissioning personnel signature</td> </tr> </table>			Date	Installer signature	Commissioning personnel signature
Date	Installer signature	Commissioning personnel signature			



## Annex

Log for the assembly acceptance measurement inspection PROFIBUS cabling

System		Segment name
		Transmission speed
Assembly acceptance performed by		
Comments		
<b>Assembly acceptance measurement</b>		
<b>OK</b>	<b>Not OK</b>	
		1. Wiring test
		No short circuit between data line A and B?
		No short circuit between data line A and shielding?
		No short circuit between data line B and shielding?
		Data core A intact?
		Data core B intact?
		Shielding intact?
		Data cores not reversed?
		Terminators only inserted on the cable ends?
		2. Interface test
		Voltage present for terminators on all interfaces?
		RS485 signal strength sufficient on all stations?
		CNTR signal present on the master?
		3. Live List
		All PROFIBUS stations are reachable at their address?
		4. Segment length measurement (cable type A)
		Maximum segment length at 9.6 kBit/s to 93.75 kBit/s: 1,200 m?
		Maximum segment length at 187.5 kBit/s: 1000 m?
		Maximum segment length at 500 kBit/s: 400 m?
		Maximum segment length at 1.5 MBit/s: 200 m?
		Maximum segment length at 3 MBit/s to 12 MBit/s: 100 m?
		5. Reflection test
		No reflection present?
Date	Installer signature	Commissioning personnel signature

## Annex

### Checklist for the assembly approval measurement PROFIBUS cabling MBP (PA)

System		Segment name
		Transmission speed
Assembly acceptance performed by		
Comments		
<b>Assembly acceptance measurement</b>		
<b>OK</b>	<b>Not OK</b>	
		1. Wiring test
		Short circuit between data line PA + and PA -?
		Short circuit between data line PA + and shielding?
		No short circuit between data line PA + and shielding?
		Data core PA+ intact?
		Data core PA- intact?
		Shielding intact?
		Data cores not reversed?
		Terminators only inserted on the cable ends?
		2. Supply voltage
		Supply voltage sufficient on all stations (at least 9 VDC)?
		Maximum supply voltage not exceeded (Ex plants: 13.5 VDC, non-Ex plants: 32 VDC)?
Date	Installer signature	Commissioning personnel signature

## Annex

### Log for commissioning/acceptance PB

System		Segment name	
		Transmission speed	
Assembly acceptance performed by			
Comments			
<b>Commissioning / Acceptance</b>			
<b>OK</b>	<b>Not OK</b>		
		1. Visual inspection (according to the visual inspection protocol)?	
		2. Acceptance measurement (according to the acceptance measurement protocol)?	
		3. Project planning	
		Project planning created?	
		Project planning stored on data media?	
		4. Address of the PROFIBUS station correctly set?	
		5. Commission masters and slaves	
		Control voltage 24 V present?	
		Project planning transferred into the master?	
		All PROFIBUS stations signal operation readiness?	
		6. Testing the signal inputs	
		24 V control voltage present?	
		Signal inputs activate?	
		IO map coincides with the signal inputs?	
		7. Testing the signal outputs	
		Control voltage of the signal outputs present?	
		Signal outputs are activated?	
		IO map does not coincide with the outputs?	
Date	Commissioning signature	personnel	Customer signature

## 5.2 Multimeter (instrument for measuring voltage, resistance, and current)

A multimeter is probably the simplest tool to use for troubleshooting in a PROFIBUS installation. With the multimeter it is possible to detect and locate errors like

- Simple "inversion" in the data lines
- Interruption of one of the two data lines
- Cable shielding interruption
- Short circuit between the data lines
- Short circuit between the data lines and the cable shield

The descriptions below list the auxiliary material you require and outline the measurement procedures.

With the measurements you can check whether the installation was executed correctly. In addition to the errors cited, the measurements also supply clues about the lengths of the PROFIBUS cable segments. They are not just helpful for simple diagnostics; they are also helpful for the assembly acceptance. You can document the measurements using the checklists in the Appendix.

The measurements do not supply values that are 100% precise, but they do provide a rough indication. However, the prerequisite for the measurements is that uniform components (PROFIBUS cable and plugs) must be used in the entire segment.

The PROFIBUS components should not be connected for the measurements.

The PROFIBUS cable must be de-energized. You can determine if the cable is de-energized by measuring the voltage between the shielding and the two data lines.

In addition, all terminators must be disconnected.

If you have permanently connected PROFIBUS components in the system, such as repeaters, then these must be disconnected. Each segment must be measured separately.

## 5.2.1 PROFIBUS RS485 with 9-Pin Sub-D Plug Connector

### *Determining loop resistance*

Loop resistance is determined by measuring the resistance of the two cores of the PROFIBUS cable. The resistance of the cores depends on the cable construction and also is temperature dependent.

Specific Cable resistance is normally specified in ohms per km at a given temperature. It is equivalent to the measured loop resistance of a 1 km long PROFIBUS cable.



A typical value for PROFIBUS RS-485 cable type A has a loop resistance of 110 ohm/km at 20°C. However, this value can deviate for special cable, e.g. highly flexible cable. Cable resistance typically increases with temperature by 0.4% per degree Celsius.

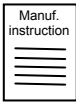

You should use the cable resistance values from the cable manufacturer's data sheets.

The measurement of cable loop resistance is relatively simple:

- At one end of the PROFIBUS cable, you must short-circuit or bridge the two cores, data core A and data core B.
- At the other end of the cable, measure the loop resistance between the two cores.
- See the PROFIBUS cable manufacturer's datasheets for the specific loop resistance (ohm/km) for the cable used.
- Using the specific loop resistance, you can estimate the length of the cable segment. Thus you can verify compliance with the permissible cable run specifications.

$$\text{Length in km} = \frac{\text{Measured loop resistance in ohms}}{\text{Specific cable resistance in ohm/km}}$$

The cable loop resistance can also be estimated from knowledge of the cable length:

Loop resistance,  $R_{loop}$ , in ohms = Cable length in km  $\times$  Specific cable resistance in ohm/km

### Example

The loop resistance of a segment of PROFIBUS RS485 type A cable is found to be  $20\Omega$  at  $20^{\circ}\text{C}$ . The estimated cable length is thus:

$$\frac{20\Omega}{110\Omega / km} = 0,182km = 182m$$

Note that the cable length estimated from resistance measurement is generally not very accurate because of the variation of specific resistance with temperature and the possible additional resistance of connectors. Cable length measurement based on signal reflection provides a more accurate estimate on installed cable length (see section 5). Executing the measurement is quite simple.

### ***Testing the PROFIBUS cable and the bus connectors***

Fig. 15 shows a schematic of a typical PROFIBUS RS485 cable with 9-pin sub-D plug connectors and termination resistors at each end. Typically the end termination resistors are mounted in the connector plugs and can be switched in or out as required. Sometimes termination resistors are built in to the PROFIBUS devices that are connected. Termination may also be provided by a separate “active terminator”, which only provides the termination resistors and a power supply.

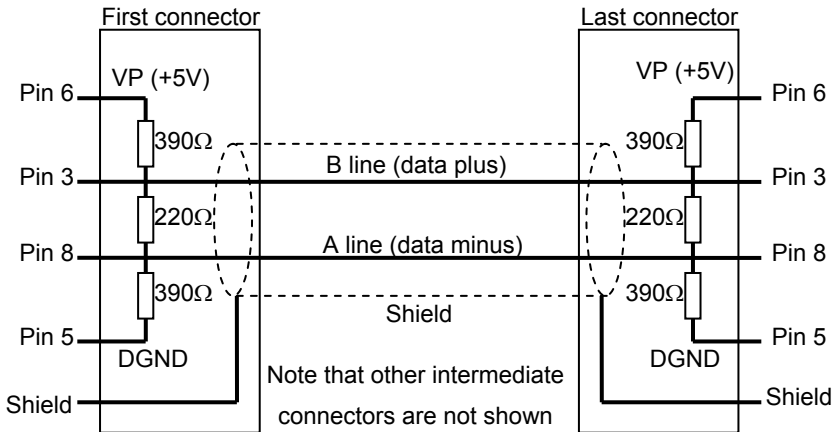

**Fig. 15: PROFIBUS RS485 cable schematic with end terminations switched in**

Measurements are made with a multimeter at each connector on the segment. All stations must be disconnected from the cable and all terminations switched off or disconnected before the testing is started. The required steps are described below. Please make this steps in every PROFIBUS segment. Step 1 checks that the cable is free of voltage from powered terminators. Step 2 checks for shorts between wires. The checks in step 1 and 2 should be performed at each connector before starting step 3. For steps 3 and 4 short circuits are introduced between selected pins in the first connector and the measurements are made on each of the remaining connectors. Failure to detect the introduced short circuit at a connector indicates a broken wire or wrongly connected cable.

A systematic method must be used in testing your cables. Steps 1 to 4 must be completed in the correct sequence in order to fully check that the cable has no wiring faults.

Step 5 is used to check the cable length by introducing a short between the A and B lines on the first connector and measuring the loop resistance at the last connector.

Finally, all shorts are removed and the termination resistors switched in and checked in step 6.

- Step 1

Using a low DC voltage range on your multimeter check that the voltage between the shield and the A and B pins of the connector is zero. Should any voltage be detected then the cable is either not disconnected from all devices or a powered termination is still switched in. Ensure the cable is voltage-free before proceeding to step 2.

- Step 2

The resistance is measured between the connector pins at each connector. Failure to measure infinite resistance indicates a short circuit, or termination resistors switched in. In order to make the measurements, you will need to estimate the cable loop resistance,  $R_{loop}$ . This can be found by multiplying the segment cable length by the specific cable resistance as shown above. The specific loop resistance of a PROFIBUS RS485 standard cable is 110  $\Omega$ /km. The specific loop resistance of the used PROFIBUS cable you can find in the data sheet of the manufacturer.

The loop resistance may be taken as zero for short cables (less than 50m). Table 5 shows the measurements that must be performed, the expected results and indicated fault. Short circuits on PROFIBUS cables can be difficult to locate since the whole cable will appear shorted by a fault in just one connector. A solution is to isolate sections of the cable until the short disappears. Special isolating connectors, which disconnect the outgoing cable when the termination resistor is switched in, can be useful for this; however you must remember that the termination resistor that is switched in will introduce a resistance of 220 $\Omega$  between the A and B lines. You may proceed to step 3 only if there are no short circuits detected and all terminations are off.



**Table 5: Resistance measurements for step 2 (PROFIBUS RS485)**

Measure the resistance between connector pins		Measured re-sistance infinite	Measured resistance $\leq R_{loop}$	Measured resistance $\approx 110\Omega$	Measured resistance $\approx 220\Omega$
Pin 8 (A line)	Pin 3 (B line)	Cable ok	Short between A and B	2 termination resistors on	1 termination resistor on
Pin 8 (A line)	Shield	Cable ok	Short between A and shield	----	----
Pin 3 (B line)	Shield	Cable ok	Short between B and shield	----	----

- Step 3

For step 3 you must introduce a short circuit between pin 8 (A line) and shield at the first connector of the tested segment. This can be done by introducing a link from pin 8 to the shield in the first connector. Measurements are then made at each of the other connectors. Table 6 shows the measurements that must be performed, the expected results and indicated fault.

**Table 6: Resistance measurements for step 3 (PROFIBUS RS485)**

Measure the resistance between connector pins		Measured resistance is infinite	Measured resistance $\approx R_{loop}$
Pin 8 (A line)	Pin 3 (B line)	Cable ok	Crossed wires A-B
Pin 8 (A line)	Shield	Open circuit in A or shield	Cable ok

- Step 4

For step 4 you must now introduce a short circuit between pin 3 (B line) and shield at the first connector of the tested segment. This can be done by introducing a link from pin 3 to the shield in the first connector. Measurements are then made at each of the other connectors. Table 7 shows the measurements that must be performed, the expected results and fault symptoms.

**Table 7: Resistance measurements for step 4 (PROFIBUS RS485)**

Measure the resistance between connector pins		Measured resistance is infinite	Measured resistance $\approx R_{loop}$
Pin 3 (B line)	Shield	Open circuit in B or shield	Cable ok

- Step 5

We measure the cable loop resistance in step 5 by introducing a short between pin 3 (B line) and pin 8 (A line). This can be done by introducing a link between pins 3 and 8 in the first connector. Loop resistance is then measured at the last connector between pin 3 (B line) and pin 8 (A line). The cable length can then be checked using the cable specific resistance.

$$\text{Length in km} = \frac{\text{Measured loop resistance in ohm}}{\text{Specific cable resistance in ohm/km}}$$

### Example

The loop resistance of a segment of PROFIBUS RS485 type-A cable is found to be  $20\ \Omega$  at  $20^\circ\text{C}$ . The estimated cable length is thus:

$$\frac{20\ \Omega}{110\ \Omega/km} = 0,182\ km = 182\ m$$

### Note:

If your installation does not have a 9-pin Sub-D plug connector at the beginning or end of the segment, then you can also perform the measurements directly on the cable cores.

### ***Measurement aid for 9-pin Sub-D plugs***

For measurements on a PROFIBUS copper cable with 9-pin Sub-D plug connectors, you can make a simple aid by using two 9-pin Sub-D sockets, a single pole toggle switch and a three-position changeover toggle switch with center off position. These components are available from specialized electronics shops.

Fig. 16 shows how to make up the two sockets; one for connecting the multimeter and the other for introducing the short-circuits described in steps 3 and 4 above.

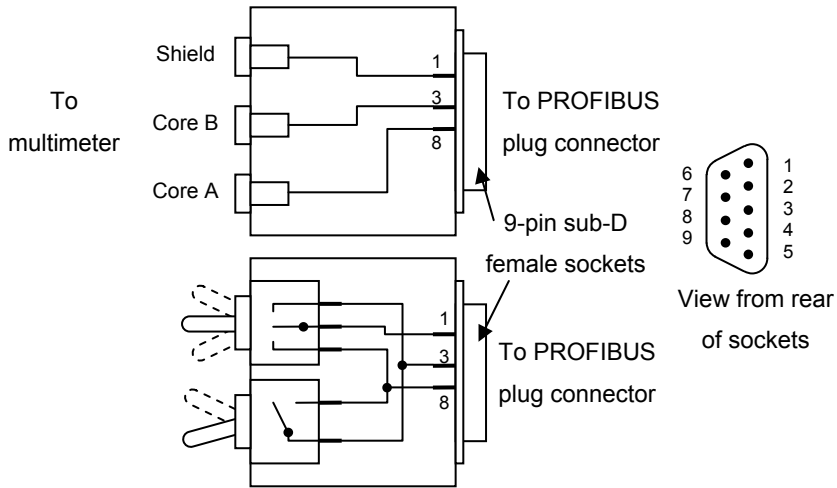

Fig. 16: Measurement aid sockets (PROFIBUS RS485)

## 5.2.2 PROFIBUS RS485 with 5-Pin M 12 Plug Connectors

The multimeter measurement for 5-pin M 12 plug connectors is similar to the measurement for 9-pin Sub-D plug connectors. You must ensure that data core A is connected to pin 2, and that data core B is connected to pin 4. A pair of measurement aid sockets can also be made for connection to M12 plugs in a similar way to the sockets shown in Fig. 16.

## 5.2.3 PROFIBUS MBP (PA) with 4-pin M 12 Plug connectors

### *Determining loop resistance*

The loop resistance if MBP (PA) wiring is measured in exactly the same way as described for RS485 wiring (chapter 5.2.1). You must measure the resistance of a loop of two cores. For this introduce a short circuit between the both cores of the PROFIBUS cable. After this measure the resistance at the other end of the cable.

In the data sheet of the manufacturer you can find the specific loop resistance. The specific loop resistance describes the loop resistance of a 1 km long PROFIBUS cable. So to compare the specific loop resistance with the measured loop resistance you must convert the measured loop resistance on cable length of 1 km. However, there are four different cable types for PROFIBUS MBP (PA). For new systems, i.e. replacement or extensions of PROFIBUS MPB only use cable types A or B. In old systems it is still quite possible to encounter cable types C or D. Typical specific loop resistance values are shown in Table 8.

**Table 8: Loop Resistance PROFIBUS MBP (PA) cable**

Cable type	A	B	C	D
Cable structure	Twisted pair, shielded	One or multiple twisted pairs, completely shielded	Multiple twisted pairs, non-shielded	Multiple non-twisted pairs, non-shielded
Core cross section	0.8 mm <sup>2</sup>	0.32 mm <sup>2</sup>	0.13 mm <sup>2</sup>	1.25 mm <sup>2</sup>
Specific Loop resistance in ohm / km	44 ohm	112 ohm	264 ohm	40 ohm



You should use the cable resistance values from the cable manufacturer's data sheets.

! Cable resistance typically increases with temperature by 0.39% per degree Celsius.

### ***Testing the PROFIBUS MBP (PA) cable and the bus connectors***

The testing of MBP (PA) cabling can be done in a similar way to that described for RS485 cabling (chapter 5.2.1). However, the termination networks for MBP (PA) segments is quite different to that for RS485, consisting of a resistor in series with a capacitor. These terminations are normally wired into junction boxes or sometimes into devices. Because MBP (PA) terminations incorporate an isolating capacitor, they do not introduce any resistance into the circuit and thus will not affect the resistance readings.

Measurements are made with a multimeter at each connector on the segment. All stations must be disconnected from the cable before the testing is started. The required steps are described below. Step 1 checks that the cable is free of any voltage. Step 2 checks for shorts between wires. The checks in step 1 and 2 should be performed at each connector before starting step 3. For steps 3 and 4 short circuits are introduced between selected pins in the first connector and the measurements are made on each of the remaining connectors. Failure to detect the introduced short circuit at a connector indicates a broken wire or wrongly connected cable.

A systematic method must be used in testing your cables. Steps 1 to 4 must be completed in the correct sequence in order to fully check that the cable has no wiring faults.

Step 5 is used to check the cable length by introducing a short between the data lines on the first connector and measuring the loop resistance at the last connector.

- Step 1

Using a low DC voltage range on your multimeter, check that the voltage between the shield and the PA+ and PA- pins of the connector is zero. Should any voltage be detected then the cable is not disconnected from all devices. Ensure the cable is volt-free before proceeding to step 2.

- Step 2

The resistance is measured between the connector pins at each connector. Failure to measure infinite resistance indicates a short circuit. In order to make the measurements, you will need to estimate the cable loop resistance,  $R_{loop}$ . This can be found by multiplying the segment cable length by the specific cable resistance as shown above. There are following specific loop resistances for PROFIBUS MBP (PA):

Cable Type	A	B	C	D
Specific loop resistance	44 Ohm	112 Ohm	264 Ohm	40 Ohm

The loop resistance may be taken as zero for short cables (less than 50m). Table 9 shows the measurements that must be performed, the expected results and indicated fault. Short circuits on PROFIBUS cables can be difficult to locate since the whole cable will appear shorted by a fault in just one connector. A solution is to isolate sections of the cable until the short disappears. You may proceed to step 3 only if there are no short circuits detected.

**Table 9: Resistance measurements for step 2 (PROFIBUS MBP (PA))**

Measure the resistance between connector pins		Measured resistance infinite	Measured resistance $\leq R_{loop}$
Pin 1 (PA+)	Pin 3 (PA-)	Cable ok	Short between PA+ and PA-
Pin 1 (PA+)	Shield	Cable ok	Short between PA+ and shield
Pin 3 (PA-)	Shield	Cable ok	Short between PA- and shield

- Step 3

For step 3 you must introduce a short circuit between pin 1 (PA+ line) and shield at the first connector of the tested segment. This can be done by introducing a link from pin 1 to the shield in the first connector.

Note: Usually the cable shield is connected to the screwed gland of the connector. Measurements are then made at each of the other connectors. Table 10 shows the measurements that must be performed, the expected results and indicated fault.

Note that many PA devices are not polarity sensitive, thus they will still work without error if the PA+ and PA- lines are crossed or swapped.

**Table 10: Resistance measurements for step 3 (PROFIBUS MBP (PA))**

Measure the resistance between connector pins		Measured resistance is infinite	Measured resistance $\approx R_{loop}$
Pin 1 (PA+)	Pin 3 (PA-)	Cable ok	Crossed wires PA+ to PA-
Pin 1 (PA+)	Shield	Open circuit in PA+ or shield	Cable ok

- Step 4

For step 4 you must now introduce a short circuit between pin 3 (PA- line) and shield at the first connector of the tested segment. This can be done by introducing a link from pin 3 to the shield in the first connector. Measurements are then made at each of the other connectors. Table 11 shows the measurements that must be performed, the expected results and fault symptoms.



**Table 11: Resistance measurements for step 4 (PROFIBUS MBP (PA))**

Measure the resistance between connector pins		Measured resistance is infinite	Measured resistance $\approx R_{loop}$
Pin 3 (PA-)	Shield	Open circuit in PA- or shield	Cable ok

- Step 5

We measure the cable loop resistance in step 5 by introducing a short between pin 1 (PA+) and pin 3 (PA-). This can be done by introducing a link between pins 1 and 3 in the first connector. Loop resistance is then measured at the last connector between pin 1 (PA+) and pin 3 (PA-). The cable length can then be checked using the cable specific resistance.

$$\text{Length in km} = \frac{\text{Measured loop resistance in ohms}}{\text{Specific cable resistance in ohm/km}}$$

**Example**

The loop resistance of a segment of PROFIBUS MBP (PA) type-A cable is found to be  $5\Omega$  at  $20^{\circ}\text{C}$ . The estimated cable length is thus:

$$\frac{5\Omega}{44\Omega/km} = 0,114 km = 114 m$$

**Note:**

If your installation does not have a 5-pin M12 plug connector at the beginning or end of the segments, then you can also perform the measurements directly on the cable cores.



---

## **6        Terms / Definitions / Abbreviations**

### Terminator

IEC 61158-2: A resistor that connects the core pairs on the end of the cable, to avoid reflections that occur at the cable ends. Ideally it should be as great as the wave resistance of the cable.

### Address (station address)

For PROFIBUS the address of a communication station (master or slave). The permissible address range is 0 to 127, with

- 126 reserved for the use of the preset addressing of a new slave
- 127 reserved for sending broadcast messages to all PROFIBUS stations.

The highest value bit of the address is used to transmit a data telegram without DSAP (Destination Service Access Point = NIL) or SSAP (Source Service Access Point) in the address field.

### Drive

A drive is an electronic output subassembly that is used to control the speed, torque, and position etc. of a DC or AC motor.

The PI supports two application profiles for drives.

### Bus cycle

The following times are defined for calculating the bus cycle and system reaction times:

Asynchronous communication

- Token Transfer Period ( $T_{TP}$ )
- Message Transfer Period ( $T_{MP}$ )
- System reaction time ( $T_{SR}$ )
- Isochronous cycle time ( $T_{CT}$ )

See IEC 61158-4 for further details and calculation formulas

### Data

IEC vocabularies: Reinterpretable depiction of information in a formal manner, suitable for communication, interpretation or automated processes.

### **Decentral peripherals (DP)**

The term "Decentral peripheral" and the abbreviation "DP" stand for a simple, fast, cyclic, and deterministic exchange of input/output data between a bus master and its associated slaves.

### **Data Link Service Access Point (DLSAP)**

IEC 61158-3: A Data Link Service Access Point is a communication access point for data connection.

### **Diagnosis**

Detection and determination of the cause of a defective reaction or unexpected reaction on the part of a PROFIBUSDP device. PROFIBUS provides auxiliary material to convert digital information into information that people can use with helpful instruction texts or graphics.

### **DIN**

Deutsches Institut für Normung (German industry standards) ([www.din.de](http://www.din.de))

### **DP master**

IEC 61158-5: A fieldbus device within PROFIBUSDP that can be a master class 1 or master class 2.

A master class 1 is a controlling device that controls multiple DP slaves.

Note: Normally this is housed in a programmable controller or in a process controller

A master class 2 is a controlling device that manages configuration data and diagnostic data (e.g. programming devices).

### **DP slave**

61158-5: A field device that is allocated to a DP master class 1, and which supplies/receives input/output data exchange. In addition acyclic functions and alarms can be transmitted.

### **Intrinsic safety (IS)**

A degree of protection in which a part of the electrical system contains only intrinsically safe components (equipment, electric circuits and wiring) that are not capable of creating an ignition in an ambient atmosphere. No individual device or no wiring is intrinsically safe on its own (with the exception of battery powered devices like pagers, transmitters-receivers, gas detectors, etc. that have been especially designed as intrinsically safe devices). It is only intrinsically safe if it has been dimensioned for operation in intrinsically safe systems. This degree of protection is identified by the letter "i".

### **EN (European norm)**

European standard/norm recognized and used by all European countries. Many of the IEC standards have been adopted as EN standard.

### **Risk**

IEC 61508-4: Potential hazard source. The term includes hazards for personnel which occur within a short time (e.g. fire and explosion) and moreover, such hazards that have a long-term effect on a person's health (e.g. toxic waste).

### **Fiber optic / optic fiber**

In industrial environments it may be the case that standard bus physics in copper technology can cause problems through interference. This problem can be solved by using fiber optic technology (see also "Optical transmission technology").

### **Manufacturer code**

The PI offers a reference list on the Internet that contains the manufacturer code, the associated company name, and additional useful information. This list is partially coordinated with the reference list provided by the Hart association.

### **IEC**

International Electronics Commission (headquartered in Geneva, Switzerland)

### **Commissioning**

The systematic process used to place a fieldbus network, the connected devices, and the associated parts of a machine or system in operation. The steps include configuration, setting parameters, programming, troubleshooting on different system levels, such as PROFIBUS diagnostics, system diagnostics, program observation etc. The project planning systems lead to these steps. Commissioning is concluded when the system works according to the planning and the customer requirements and when the system documentation has been concluded.

### **Communication**

For PROFIBUS this means the electronic transfer of digital data from one network station to another.

### **Optical transmission**

IEC 61158-2: Transmission physics with the following characteristics:

- Optical fiber made out of quartz (glass) or plastic
- Great distances, independent of the transfer rate
- Immune to electromagnetic interferences
- Galvanic isolation between connected stations
- Star, ring, line and mixed wiring structures
- Connection to electrical network segments possible
- Transfer rates: 9.6 / 19.2 / 45.45 / 93.75 / 187.5 / 500 kBit/s, 1.5 / 3 / 12 Mbit

Possible optical fibers

- Multimode optical fiber
- Singlemode optical fiber
- Plastic fiber
- HCS optical fiber

### **PROFIBUS**

IEC 61784-1: Communication network according to the communication profile family 3 (CPF 3), unifying application profiles and system integration aspects, such as interfaces, languages for project planning tools, and HMI.

PROFIBUS is an open, digital communication system with a broad field of applications, specifically in the area of factory and process automation. PROFIBUS is suitable for fast, time-critical applications and complex communication processes.

### **PROFIBUS components**

Refers to all components that make up a PROFIBUS network (e.g. cables, plug connectors, etc.)

### **PROFIBUS components**

Designates all components, that comprise a PROFIBUS network (e.g. cable, plug connectors, master/slave interfaces, repeaters, etc.)

### **PROFIBUS-MBP (PA)**

Refers to the transmission technology PROFIBUS Manchester-coded & bus-powered. PROFIBUSMBP (PA) is used for synchronous data transmission.



### **PROFIBUS User Organization (PI)**

PROFIBUS & PROFINET International authorized PROFIBUS Nutzerorganisation e.V. (PI Germany) to set up Committees (C), Working Groups (WG) and Project Groups (PG) to define and maintain the open, and manufacturer-independent PROFIBUS standard. The PI was founded in 1989. The PI is a non-profit organization headquartered in Karlsruhe Germany. Members of PROFIBUS International are entitled to participate in the Technical Committees and the Working Groups of the PI. A member can take an active role in the maintenance and further development of PROFIBUS. This ensures openness and manufacturer independence of PROFIBUS technology. Additional information can be found under <http://www.profibus.com/pi-organization>.

### **PROFIBUS PA**

Refers to "PROFIBUS for Process Automation". This is an application profile based on PROFIBUS DP and independent of the physical layout (RS485, optical, MBP (PA)). The requirements for continuous manufacturing are covered within the "PA devices" application profile.

### **RS485**

Refers to the standard transfer technology for PROFIBUS that operates with a data transfer technology according to the RS485 standard. PROFIBUS RS485 is used for asynchronous data transmission.

### **RS485-IS**

Refers to a PROFIBUS transfer technology that operates according to the RS485 standard. IS refers to Intrinsic Safety. Thus this technology can be used in hazardous areas.

### **PROFIBUS station**

Device that communicates with other devices via the PROFIBUS cable (master, slave)

### **PROFIsafe**

Communication technology that is especially adapted to the requirements of safety-oriented, distributed, discrete, and continuous manufacturing.

In the PROFIBUS implementation area "PROFIsafe is used for PROFIBUS applications in the factory and process automation together with the corresponding PROFIsafe technology for all transmission technologies (e.g. RS485, MBP (PA), optic).

Note: A PROFIsafe slave must be realized in such a manner that it agrees with the standards derived from IEC 65108. The implementation of safe communication is not sufficient for functional safety.

The PI maintains the following "PROFIsafe" specifications

- PROFIsafe – Profile for safety technology, Order Nr. 3.092
- PROFIsafe Policy, Order Nr. 2.282
- PROFIsafe – Requirements for Installation, Immunity and electrical safety, Order Nr. 2.232
- PROFIsafe – Test Specification for safety related PROFIBUS DP-Slaves, Order Nr. 2.242

### **Programming device**

There are many types of programming devices and/or software that match the size of the respective programmable logic controller (PLC) and are sold by the manufacturer.

- Single command programming devices: This programming device is useful for small changes in an existing program
- Specific computer hardware and software that is always assigned by the manufacturer for special programming languages, such as "ladder logic", contain special functions for automation applications or for industrial environments. These programming devices are extended into project planning tools and, therefore, enable all commissioning steps.
- PC-compatible software to allow use of a standard PC or a notebook as programming device. Special hardware is required to complete this system as a project-planning tool, e.g. a PROFIBUS DP interface.

### **Interface**

General term for each connection and interaction between hardware, software, and the user.

Additional PROFIBUS terms are available in the PROFIBUS & PROFINET Glossary at [www.profibus.com](http://www.profibus.com).



**7      Index**

Assembly acceptance	
acceptance measurements optical fibers.....	33
Assembly Acceptace	
Acceptance Measurements PROFIBUS MBP .....	31
Acceptance Measurements PROFIBUS RS-485 .....	28
Assembly Acceptance .....	23
Visual Inspection.....	25
Commissioning / Acceptance.....	35
Commissioning PROFIBUS stations.....	41
Commissioning the Bus .....	37
Create Acceptance Checklist.....	43
Create Project Planning .....	37
Testing the Signal Inputs .....	42
Testing the Signal Outputs.....	42
Optical fiber.....	18
Insertion Measurement Process .....	18
Optical Fiber	
Acceptance Measurements .....	32
Damping Measurement.....	18
<b>Maximum fiber attenuation</b> .....	19
Measurement Results Damping Measurement.....	32
Necessity of the Acceptance Measurements .....	32
Simple PROFIBUS Diagnostics .....	15
4-pin M12 plug connector PROFIBUS MBP .....	85
5-pin M12 plug connector PROFIBUS RS-485 .....	84
9-pin Sub-D plug connector .....	77
Counters and Diagnostics Buffer .....	21
Handheld devices .....	17
Introduction .....	16
Loop Resistance PROFIBUS MBP .....	85
Loop Resistance PROFIBUS RS-485.....	77

---

## Index

---

Multimeter .....	76
Optical fibers .....	18
PROFIBUS MBP cable .....	86
Testing PROFIBUS cable RS-485 .....	78
Troubleshooting .....	45
Bus Monitor .....	48
Checking the Cabling Infrastructure .....	47
Defective Bus Terminator .....	61
Introduction .....	46
Non-Connected PROFIBUS Plugs .....	60
Oscilloscope – Measurement Aids .....	52
Oscilloscope - Technical Prerequisites .....	51
Oscilloscope Measurements .....	51
Oscilloscope Measurements PROFIBUS MBP .....	64
Oscilloscope Measurements PROFIBUS RS-485 .....	53
PROFIBUS cable too long PROFIBUS RS-485 .....	59
Signal form PROFIBUS RS-485 .....	59
Signal Form PROFIBUS-MBP .....	65
Typical Signal Waveforms PROFIBUS RS-485 .....	59
Troubleshooting:Signal Form PROFIBUS MBP .....	65

---

## **Addresses**

### PROFIBUS Competence Center

PROFIBUS Competence Centers are points of contact if there are problems with PROFIBUS. Competence Centers have specialists that can assist you if you are experiencing problems with PROFIBUS. In addition Competence Centers conduct training and develop new components for PROFIBUS. Competence Centers can be found in many countries throughout the world. Current addresses of the PROFIBUS Competence Centers are listed on the Internet at [www.profibus.com](http://www.profibus.com) in the support area.





---

© Copyright by

PROFIBUS Nutzerorganisation .e.V.

Haid-und-Neu-Str. 7

76131 Karlsruhe

Germany

Phone: +49 721 / 96 58 590

Fax: +49 721 / 96 58 589

<mailto:pi@profibus.com>

[www.profibus.com](http://www.profibus.com)